

# 8kg Combi Hammer

Operators Manual



Ramset™



# DynaDrill™ 585



RVC

RAMSET  
VIBRATION  
CONTROL

TO REDUCE THE RISK OF INJURY, USER MUST READ OPERATOR'S MANUAL.





# Safety Notes

## General Power Tool Safety Warnings

**⚠️ WARNING** Read all safety warnings and all instructions.

Failure to follow the warnings and instructions may result in electric shock, fire and/or serious injury.

**Save all warnings and instructions for future reference.** The term “power tool” in the warnings refers to your mains-operated (corded) power tool or battery-operated (cordless) power tool.

## Work area safety

- ▶ **Keep work area clean and well lit.** Cluttered or dark areas invite accidents.
- ▶ **Do not operate power tools in explosive atmospheres, such as in the presence of flammable liquids, gases or dust.** Power tools create sparks which may ignite the dust or fumes.
- ▶ **Keep children and bystanders away while operating a power tool.** Distractions can cause you to lose control.

## Electrical safety

- ▶ **Power tool plugs must match the outlet. Never modify the plug in any way. Do not use any adapter plugs with earthed (grounded) power tools.** Unmodified plugs and matching outlets will reduce risk of electric shock.
- ▶ **Avoid body contact with earthed or grounded surfaces, such as pipes, radiators, ranges and refrigerators.** There is an increased risk of electric shock if your body is earthed or grounded.
- ▶ **Do not expose power tools to rain or wet conditions.** Water entering a power tool will increase the risk of electric shock.
- ▶ **Do not abuse the cord. Never use the cord for carrying, pulling or unplugging the power tool.** Keep cord away from heat, oil, sharp edges and moving parts. Damaged or entangled cords increase the risk of electric shock.
- ▶ **When operating a power tool outdoors, use an extension cord suitable for outdoor use.** Use of a cord suitable for outdoor use reduces the risk of electric shock.
- ▶ **If operating a power tool in a damp location is unavoidable, use a residual current device (RCD) protected supply.** Use of an RCD reduces the risk of electric shock.

## Personal safety

- ▶ **Stay alert, watch what you are doing and use common sense when operating a power tool.** Do not use a power tool while you are tired or under the influence of drugs, alcohol or medication. A moment of inattention while operating power tools may result in serious personal injury.
- ▶ **Use personal protective equipment.** Always wear eye protection. Protective equipment such as dust mask, non-skid safety shoes, hard hat, or hearing protection used for appropriate conditions will reduce personal injuries.
- ▶ **Prevent unintentional starting. Ensure the switch is in the off-position before connecting to power source and/or battery pack, picking up or carrying the tool.** Carrying power tools with your finger on the switch or energising power tools that have the switch on invites accidents.
- ▶ **Remove any adjusting key or wrench before turning the power tool on.** A wrench or a key left attached to a rotating part of the power tool may result in personal injury.
- ▶ **Do not overreach. Keep proper footing and balance at all times.** This enables better control of the power tool in unexpected situations.
- ▶ **Dress properly. Do not wear loose clothing or jewellery. Keep your hair, clothing and gloves away from moving parts.** Loose clothes, jewellery or long hair can be caught in moving parts.
- ▶ **If devices are provided for the connection of dust extraction and collection facilities, ensure these are connected and properly used.** Use of dust collection can reduce dust-related hazards.

## Power tool use and care

- ▶ **Do not force the power tool. Use the correct power tool for your application.** The correct power tool will do the job better and safer at the rate for which it was designed.
- ▶ **Do not use the power tool if the switch does not turn it on and off.** Any power tool that cannot be controlled with the switch is dangerous and must be repaired.
- ▶ **Disconnect the plug from the power source and/or the battery pack from the power tool before making any adjustments, changing accessories, or storing power tools.** Such preventive safety measures reduce the risk of starting the power tool accidentally.

- ▶ **Store idle power tools out of the reach of children and do not allow persons unfamiliar with the power tool or these instructions to operate the power tool.** Power tools are dangerous in the hands of untrained users.
- ▶ **Maintain power tools. Check for misalignment or binding of moving parts, breakage of parts and any other condition that may affect the power tool's operation. If damaged, have the power tool repaired before use.** Many accidents are caused by poorly maintained power tools.
- ▶ **Keep cutting tools sharp and clean.** Properly maintained cutting tools with sharp cutting edges are less likely to bind and are easier to control.
- ▶ **Use the power tool, accessories and tool bits etc. in accordance with these instructions, taking into account the working conditions and the work to be performed.** Use of the power tool for operations different from those intended could result in a hazardous situation.

## Service

- ▶ **Have your power tool serviced by a qualified repair person using only identical replacement parts.** This will ensure that the safety of the power tool is maintained.

## Hammer Safety Warnings

- ▶ **Wear ear protectors.** Exposure to noise can cause hearing loss.
- ▶ **Use auxiliary handle(s), if supplied with the tool.** Loss of control can cause personal injury.
- ▶ **Hold power tool by insulated gripping surfaces, when performing an operation where the cutting accessory may contact hidden wiring or its own cord.** Cutting accessory contacting a "live" wire may make exposed metal parts of the power tool "live" and could give the operator an electric shock.
- ▶ Use a residual current device (RCD) with a rated residual current of 30 mA or less.

## Additional Safety and Working Instructions

- ▶ **Observe the mains voltage!** The voltage of the power source must correspond with the data on the type plate of the machine.
- ▶ **Use appropriate detectors to determine if utility lines are hidden in the work area or call the local utility company for assistance.** Contact with electric lines can lead to fire and

electric shock. Damaging a gas line can lead to explosion. Penetrating a water line causes property damage.

- ▶ **Firmly tighten the auxiliary handle, hold the machine firmly with both hands while working and keep proper footing and balance at all times.** The machine is securely guided with both hands.
- ▶ **Insert the SDS-max application tool:** Check the latching by pulling the tool.
- ▶ **Replace a damaged dust protection cap immediately.** The dust protection cap largely prevents the penetration of drilling dust into the tool holder during operation. When inserting the tool, pay attention that the dust protection cap is not damaged.
- ▶ **Dusts from materials such as lead-containing coatings, some wood types, minerals and metal can be harmful to one's health and cause allergic reactions, lead to respiratory infections and/or cancer.** Materials containing asbestos may only be worked by specialists.
  - As far as possible, use a dust extraction system suitable for the material.
  - Provide for good ventilation of the working place.
  - It is recommended to wear a P2 filter-class respirator.
  - Observe the relevant regulations in your country for the materials to be worked.
- ▶ To save energy, only switch the power tool on when using it.

- ▶ **Always wait until the machine has come to a complete stop before placing it down.** The tool insert can jam and lead to loss of control over the power tool.

### ▶ Restarting Protection

In chiselling mode, the restarting protection prevents uncontrolled starting of the machine after a power failure.

- To restart the operation, switch the On/Off switch to the Off position and start the machine again.

### ▶ Vibration Damper (DD585)















The integrated vibration damper reduces occurring vibrations.

# Symbols

The following symbols are important for reading and understanding the operating instructions. Please take note of the symbols and their meaning. The correct interpretation of the symbols will help you to use the machine in a better and safer manner.

Symbol	Meaning
	DynaDrill™ 585 Combi Hammer Grey-marked area: Handle (insulated gripping surface)
	Article number
	Read all safety warnings and all instructions
	Before any work on the machine itself, pull the mains plug from the socket outlet
	Wear protective gloves
	Always wear ear protection
	Wear safety glasses/goggles
	Movement direction
	Reaction direction
	Next step of action
	Prohibited action
	Hammer Drilling
	Chiselling
	Vario-Lock
	Switching On
	Switching Off
	On/Off switch lock-on
	Releasing the On/Off switch

Symbol	Meaning
	Low speed/impact rate
	High speed/impact rate
	Tool holder
	Apply a light coat of grease to the shank end of the application tool
	Service Indicator
$P_1$	Rated power input
E	Impact energy per stroke according to EPTA-Procedure 05/2009
$n_0$	No-load speed
	Restarting Protection
$\emptyset$	Drilling diameter, max.
	Concrete
	Brickwork
	Twist drill bit
	Break-through drill bit
	Core bit
	Weight according to EPTA-Procedure 01/2003
	Protection class
$L_{WA}$	Sound power level
$L_{pA}$	Sound pressure level
$a_1$	Vibration total value
K	Uncertainty

## Delivery Scope

Combi hammer, auxiliary handle. Application tools and other accessories shown or described are not part of the standard delivery scope.

## Intended Use

The machine is intended for hammer drilling in concrete, brick and stone, as well as for chiselling.

## Technical Data

The technical data of the machine are listed in the table on page 7.

## Noise/Vibration Information

The measured values of the machine are listed in the table on page 7. Noise and vibrational values (vector sum of three directions) determined according to EN 60745. The vibration emission level given in this information sheet has been measured in accordance with a standardised test given in EN 60745 and may be used to compare one tool with another. It may be used for a preliminary assessment of exposure.

The declared vibration emission level represents the main applications of the tool. However if the tool is used for different applications, with different

accessories or poorly maintained, the vibration emission may differ. This may significantly increase the exposure level over the total working period.

An estimation of the level of exposure to vibration should also take into account the times when the tool is switched off or when it is running but not actually doing the job. This may significantly reduce the exposure level over the total working period.

Identify additional safety measures to protect the operator from the effects of vibration such as: maintain the tool and the accessories, keep hands warm, organise work patterns.

## Mounting and Operation

Action	Figure	Please observe			Page
Insert the SDS-max application tool		1			8
Removing the SDS-max application tool		2			8
Selecting the Operating Mode		3			9
Changing the chisel position (Vario-Lock)		4			9
Changing the position of the auxiliary handle		5			9
Switching On/Off in Drilling Mode		6			10
Switching On/Off in Chiselling Mode		7			10
Adjusting the Speed		8			10
Observing the service indicator		9			11

## Maintenance and Cleaning

- ▶ **Before any work on the machine itself, pull the mains plug.**
- ▶ **For safe and proper working, always keep the machine and ventilation slots clean.**
- ▶ **A damaged dust protection cap should be changed immediately. We recommend having this carried out by the Ramset Service Centre.**

If the replacement of the supply cord is necessary, this has to be done by the Ramset Service Centre in order to avoid a safety hazard.

## Service Indicator

(see Fig. 9, page 11)

When the carbon brushes are worn out, the machine switches itself off. This is indicated approx. 8 hours beforehand by the lighting or blinking of the service indicator. The machine must then be sent to the Ramset Service Centre. Addresses are listed on the last page.

“After-sales Service and Application Service”.

Service indicator flashes in regular intervals, the machine is defective. In this case, do not continue to use the machine and send it immediately to the Ramset service centre.

## After-sales Service and Customer Assistance

Our after-sales service responds to your questions concerning maintenance and repair of your product as well as spare parts.

### Australia

Tel: 1300 780 063

Fax: 1300 780 064

www.ramset.com.au

### New Zealand

Tel: +64 9444 3510

Fax: +64 9444 2864

www.ramset.com.nz

## Disposal

The machine, accessories and packaging should be sorted for environmental-friendly recycling.







Do not dispose of power tools into household waste!

### Only for EC countries:

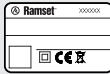
According the European Guideline 2012/19/EU for Waste Electrical and Electronic Equipment and its implementation into national right, power tools that are no longer usable must be collected separately and disposed of in an environmentally correct manner.



**Subject to change without notice.**

		DynaDrill™ 585	
		✓	Restart Protection
		✓	Ramset™ Vibration Control
$P_1$	W	1500	Rated Power input
$n_0$	$\text{min}^{-1}$	0 - 305	Impact frequency at rated speed
E	J	12.5	Impact energy per stroke according to EPTA-procedure 05/2009
	$\text{m/s}^2$	8	Vibration emission value 9h
	$\text{m/s}^2$	1,5	Uncertainty K
Ø max.			
		mm	45
		mm	80
		mm	125
	kg	8.9	Weight
		II	Protection Class

1

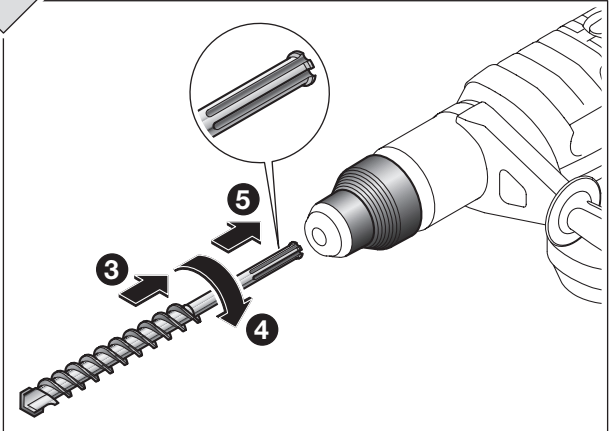
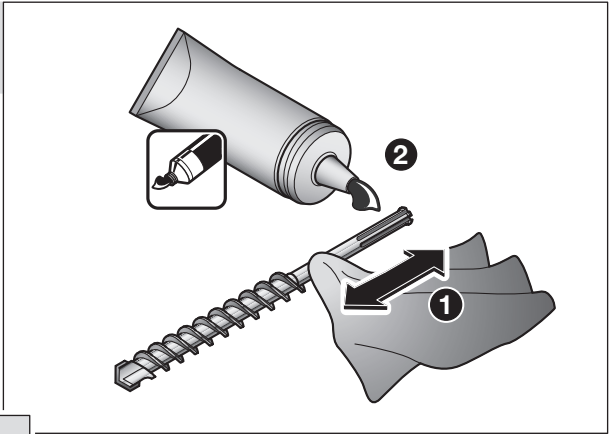
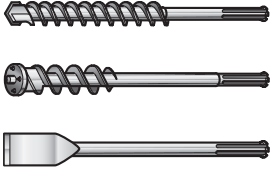

2

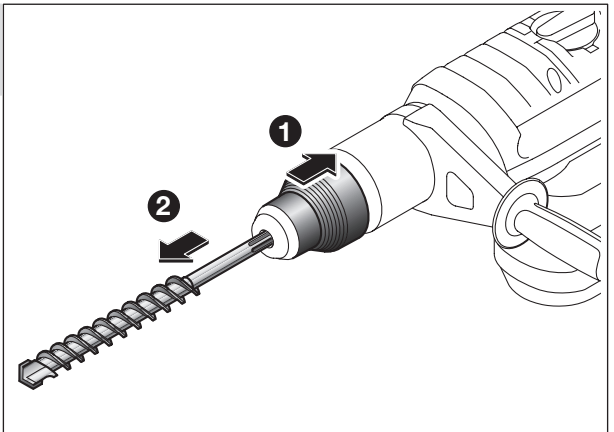
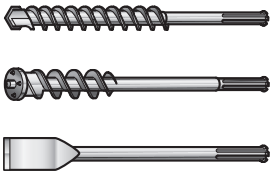



3

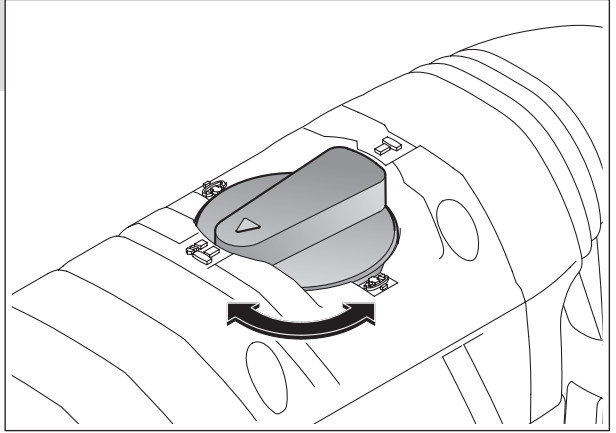

4

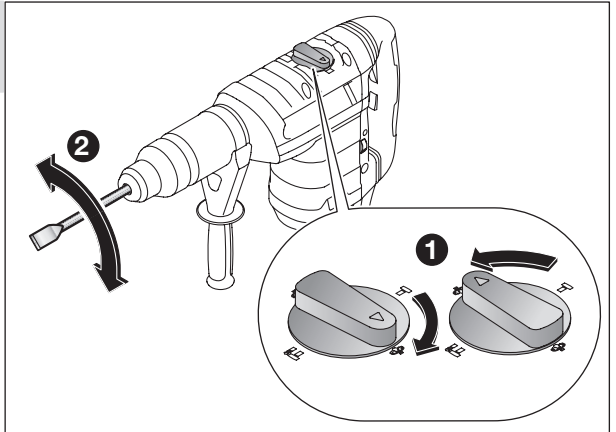

5

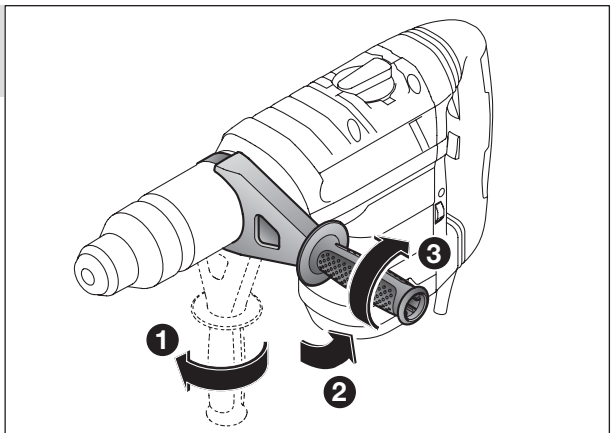
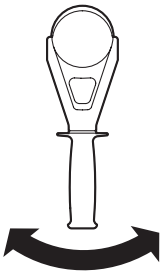

6

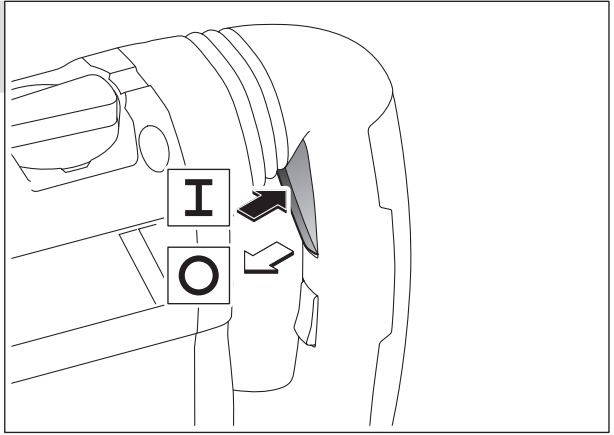
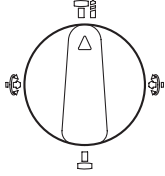

7

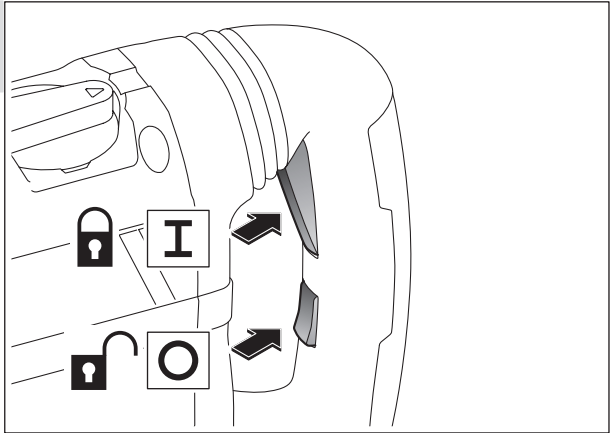
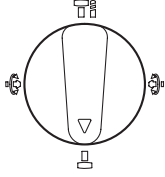

8

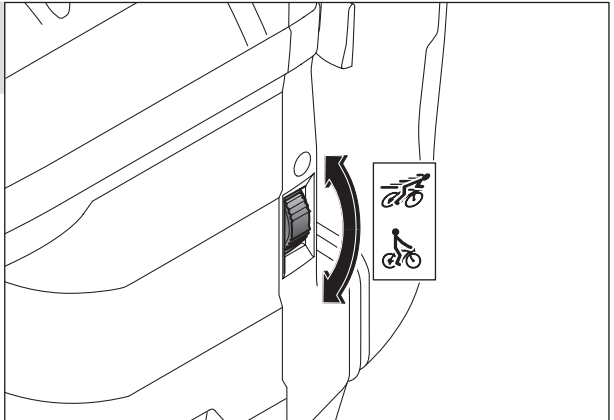

9

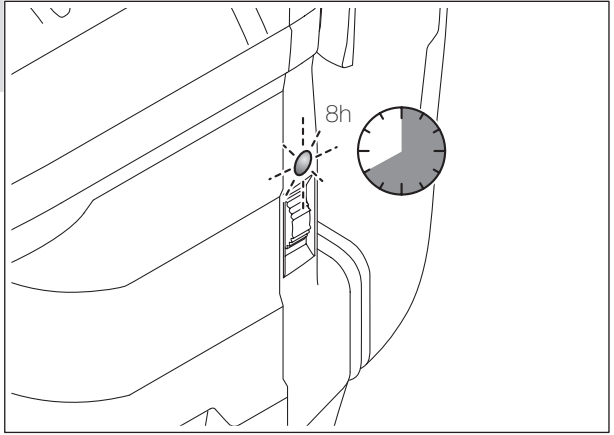

# 8kg Combi Hammer

## Operators Manual



# Ramset™

### ONE YEAR WARRANTY

This Ramset™ tool is warranted to the original purchaser only to be free from defects in material and workmanship. will repair or replace subject to certain exceptions, Ramset which, after examination, is determined by Ramset™ to be defective in material or workmanship for a period of one (1) years\* after the date of purchase. Return the tool and a copy of proof of purchase to the Ramset™ National Service Centre, freight prepaid and insured, as requested for this warranty to be effective. This warranty does not apply to damage that Ramset™ determines to be from repairs made or attempted by anyone other than Ramset™ authorized personnel, misuse, alterations, abuse, normal wear and tear, lack of maintenance, or accidents.

ACCEPTANCE OF THE EXCLUSIVE REPAIR AND REPLACEMENT REMEDIES DESCRIBED HEREIN IS A CONDITION OF THE CONTRACT FOR THE PURCHASE OF EVERY Ramset™ PRODUCT. IF YOU DO NOT AGREE TO THIS CONDITION, YOU SHOULD NOT PURCHASE THE PRODUCT. IN NO EVENT SHALL Ramset™ BE LIABLE FOR ANY INCIDENTAL, SPECIAL, CONSEQUENTIAL OR PUNITIVE DAMAGES, OR FOR ANY COSTS, ATTORNEY FEES, EXPENSES, LOSSES OR DELAYS ALLEGED TO BE AS A CONSEQUENCE OF ANY DAMAGE TO, FAILURE OF, OR DEFECT IN ANY PRODUCT INCLUDING, BUT NOT LIMITED TO, ANY CLAIMS FOR LOSS OF PROFITS. THIS WARRANTY IS EXCLUSIVE AND IN LIEU OF ALL OTHER WARRANTIES OR CONDITIONS, WRITTEN OR ORAL, EXPRESSED OR IMPLIED. WITHOUT LIMITING THE GENERALITY OF THE FOREGOING, Ramset™ DISCLAIMS ANY IMPLIED WARRANTY OF MERCHANTABILITY OR FITNESS FOR A PARTICULAR USE OR PURPOSE, AND ALL OTHER WARRANTIES.

### Ramset™ A division of ITW Australia Pty Ltd.

In addition to other rights and remedies that may be available under law, our goods come with guarantees that cannot be excluded under the Australian Consumer Law. You are entitled to a replacement or refund for a major failure and for compensation for any other reasonable foreseeable loss or damage. You are also entitled to have the goods repaired or replaced if the goods fail to be of acceptable quality and the failure does not amount to a major failure.

---

### ITW Ramset Australia Pty Ltd

1 Ramset Drive  
Chirside Park Victoria  
AUSTRALIA 3116.  
Postal: P.O. Box 192, Croydon, 3136  
Tel.: 1300 780 063  
Fax: 1300 780 064  
Web: [www.ramset.com.au](http://www.ramset.com.au)

### Ramset (N.Z) Limited

23-29 Poland Rd  
Glenfield  
Auckland  
NEW ZEALAND  
Tel.: +64 9 444 3510  
Fax: +64 9 444 2864  
Web: [www.ramset.co.nz](http://www.ramset.co.nz)

