

Approval body for construction products  
and types of construction

Bautechnisches Prüfamt

An institution established by the Federal and  
Laender Governments



## European Technical Assessment

ETA-20/0730  
of 13 November 2020

English translation prepared by DIBt - Original version in German language

### General Part

Technical Assessment Body issuing the  
European Technical Assessment:

Deutsches Institut für Bautechnik

Trade name of the construction product

AnkaScrew Xtrem

Product family  
to which the construction product belongs

Fasteners for use in concrete for redundant non-structural  
systems

Manufacturer

Ramset Reid  
1 Ramset Drive  
CHIRNSIDE PARK, VIC 3116  
AUSTRALIEN

Manufacturing plant

Plant 1

This European Technical Assessment  
contains

16 pages including 3 annexes which form an integral part  
of this assessment

This European Technical Assessment is  
issued in accordance with Regulation (EU)  
No 305/2011, on the basis of

EAD 330747-00-0601, Edition 06/2018

The European Technical Assessment is issued by the Technical Assessment Body in its official language. Translations of this European Technical Assessment in other languages shall fully correspond to the original issued document and shall be identified as such.

Communication of this European Technical Assessment, including transmission by electronic means, shall be in full. However, partial reproduction may only be made with the written consent of the issuing Technical Assessment Body. Any partial reproduction shall be identified as such.

This European Technical Assessment may be withdrawn by the issuing Technical Assessment Body, in particular pursuant to information by the Commission in accordance with Article 25(3) of Regulation (EU) No 305/2011.

## Specific Part

### 1 Technical description of the product

The concrete screw AnkaScrew Xtrem is an anchor of size 5 and 6 mm made of galvanised steel respectively steel with zinc flake coating and of stainless steel. The anchor is screwed into a predrilled cylindrical drill hole. The special thread of the anchor cuts an internal thread into the member while setting. The anchorage is characterised by mechanical interlock in the special thread.

The product description is given in Annex A.

### 2 Specification of the intended use in accordance with the applicable EAD

The performances given in Section 3 are only valid if the anchor is used in compliance with the specifications and conditions given in Annex B.

The verifications and assessment methods on which this European Technical Assessment is based lead to the assumption of a working life of the anchor of at least 50 years. The indications given on the working life cannot be interpreted as a guarantee given by the producer, but are to be regarded only as a means for choosing the right products in relation to the expected economically reasonable working life of the works.

### 3 Performance of the product and references to the methods used for its assessment

#### 3.1 Safety in case of fire (BWR 2)

Essential characteristic	Performance
Reaction to fire	Class A1
Resistance to fire	See Annex C 3

#### 3.2 Safety in use (BWR 4)

Essential characteristic	Performance
Characteristic resistance to tension load (static and quasi-static loading)	See Annex B 2, Annex C 1 and C 2
Characteristic resistance to shear load (static and quasi-static loading)	See Annex C 1 and C 2
Durability	See Annex B 1

### 4 Assessment and verification of constancy of performance (AVCP) system applied, with reference to its legal base

In accordance with European Assessment Document EAD No. 330747-00-0601, the applicable European legal act is: [97/161/EC].

The system to be applied is: 2+

**5 Technical details necessary for the implementation of the AVCP system, as provided for in the applicable European Assessment Document**

Technical details necessary for the implementation of the AVCP system are laid down in the control plan deposited at Deutsches Institut für Bautechnik.

Issued in Berlin 13 November 2020 by Deutsches Institut für Bautechnik

Dipl.-Ing. Beatrix Wittstock  
Head of Section

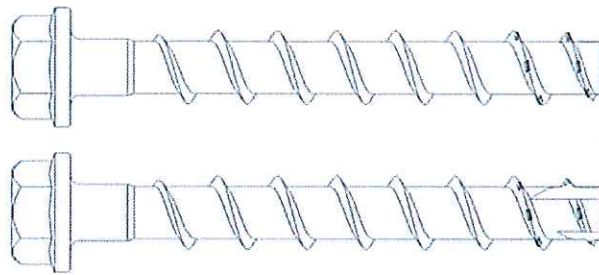
*beglaubigt:*  
Tempel



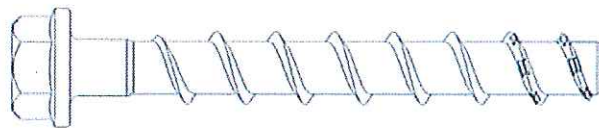
## Product in installed condition

### Ramset™ AnkaScrew™ Xtrem™ (5 and 6)

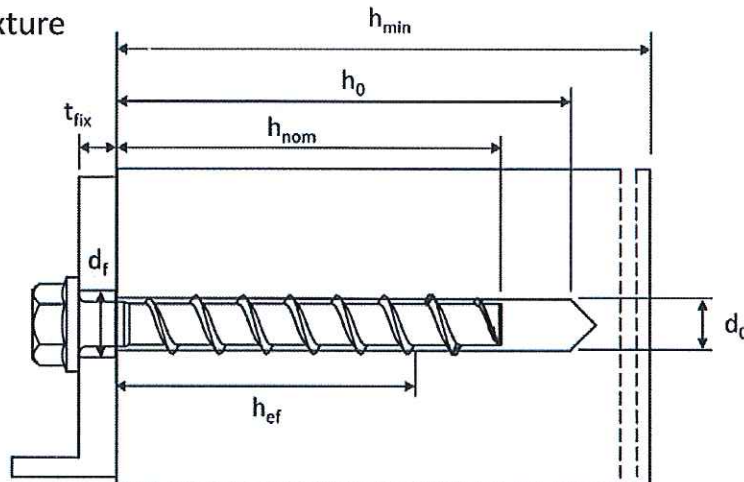
- Galvanized carbon steel
- Zinc flakes coated carbon steel



- Stainless steel A4
- Stainless steel HCR



e.g. Ramset™ AnkaScrew™ Xtrem™ , zinc flakes coated, with hexagon head and fixture



$d_0$  = nominal drill hole diameter  
 $t_{fix}$  = thickness of fixture  
 $d_f$  = clearance hole diameter

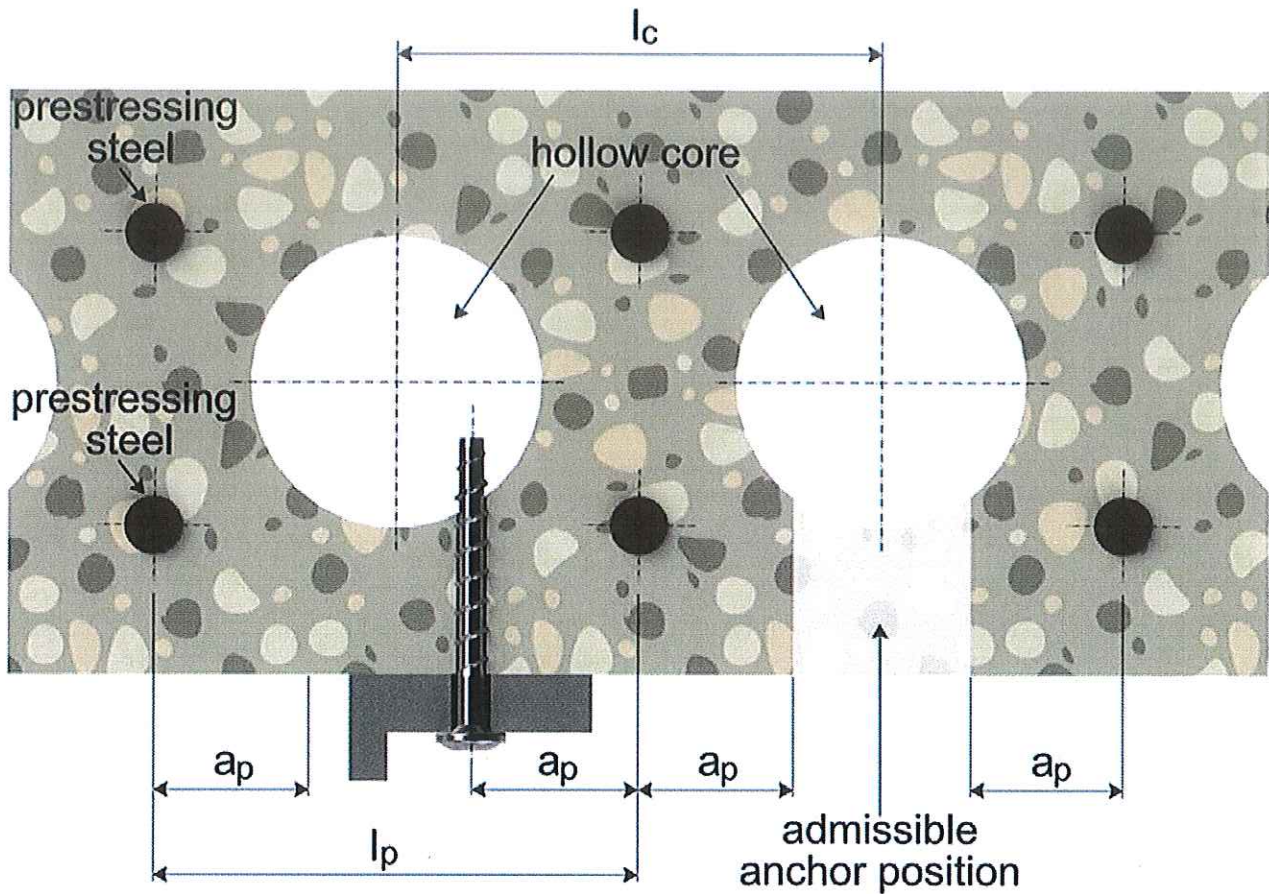
$h_{min}$  = minimum thickness of member  
 $h_{nom}$  = nominal embedment depth  
 $h_0$  = drill hole depth  
 $h_{ef}$  = effective embedment depth

Ramset™ AnkaScrew™ Xtrem™

**Product description**  
Product in installed condition

**Annex A1**

## Installed condition in precast prestressed hollow core slabs



Important ratio:  $\frac{w}{e} \leq 4,2$

$w$  = core width

$e$  = web thickness

$l_c$  = core distance  $\geq 100$  mm

$l_p$  = prestressing steel  $\geq 100$  mm

$a_p$  = distance between anchor position and prestressing steel  $\geq 50$ mm

Ramset™ AnkaScrew™ Xtrem™

### Product description

Installed condition in precast prestressed hollow core slabs

Annex A2

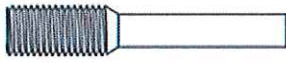





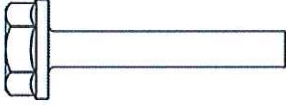

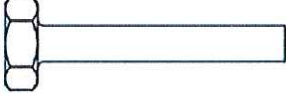

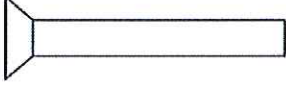

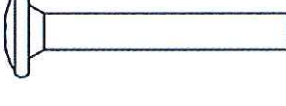

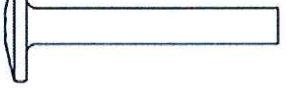

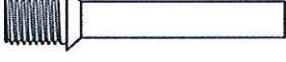

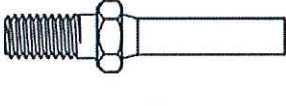

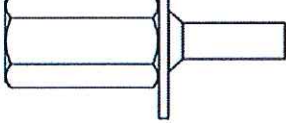

		Configuration with metric connection thread and hexagon socket e.g. AS08105XM10
		Configuration with metric connection thread and hexagon drive e.g. AS08105XM10H
		Configuration with washer and hexagon head e.g. AS08080X
		Configuration with washer, hexagon head and TORX drive e.g. AS08080XT
		Configuration with hexagon head e.g. AS08080XH
		Configuration with countersunk head and TORX drive e.g. AS08080XF
		Configuration with pan head and TORX drive e.g. AS08080XR
		Configuration with large pan head and TORX drive e.g. AS08080XLR
		Configuration with countersunk head and connection thread e.g. AS06055XM8CS
		Configuration with hexagon drive and connection thread e.g. AS06055XHN
		11. Configuration with internal thread and hexagon drive e.g. AS06055XMS
<b>Ramset™ AnkaScrew™ Xtrem™</b>		
<b>Product description</b> Screw types		<b>Annex A3</b>

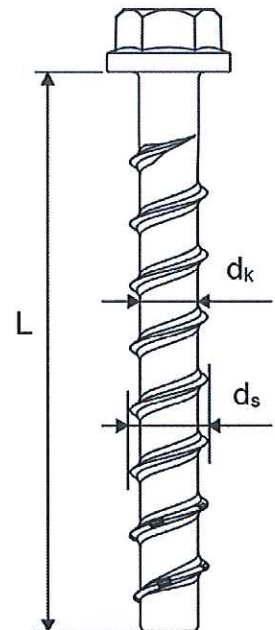


Table 1: Material

Part	Product name	Material		
all types	AnkaScrew Xtrem	- Steel EN 10263-4:2017 galvanized acc. to EN ISO 4042:2018 - Zinc flake coating according to EN ISO 10683:2018 ( $\geq 5\mu\text{m}$ )		
	AnkaScrew Xtrem A4	1.4401; 1.4404; 1.4571; 1.4578		
	AnkaScrew Xtrem HCR	1.4529		
Part	Product name	Nominal characteristic steel		Rupture elongation $A_5$ [%]
		Yield strength $f_{yk}$ [N/mm <sup>2</sup> ]	Ultimate strength $f_{uk}$ [N/mm <sup>2</sup> ]	
all types	AnkaScrew Xtrem	560	700	$\leq 8$
	AnkaScrew Xtrem A4			
	AnkaScrew Xtrem HCR			

Table 2: Dimensions

Anchor size			5	6
Screw length	$\leq L$	[mm]	200	
Core diameter	$d_k$	[mm]	4,0	5,1
Thread outer diameter	$d_s$	[mm]	6,5	7,5



**Marking:**

**AnkaScrew Xtrem:**

Screw type: TAPCON  
Screw size: 10  
Screw length: 100

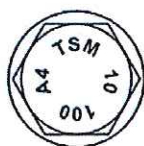
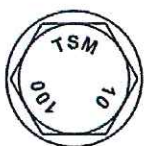
**AnkaScrew Xtrem A4**

Screw type: TAPCON  
Screw size: 10  
Screw length: 100  
Material: A4

**AnkaScrew Xtrem HCR**

Screw type: TAPCON  
Screw size: 10  
Screw length: 100  
Material: HCR

Marking "k" or "x" for anchors with connection thread and  $h_{nom} = 35\text{mm}$



Ramset™ AnkaScrew™ Xtrem™

**Product description**  
Material, Dimensions and markings

**Annex A4**



## Specification of Intended use

### Anchorage subject to:

- static and quasi static loads
- Used only for multiple use for non-structural application according to EN 1992-4:2018
- Used for anchorages with requirements related to resistance of fire (not for using in prestressed hollow core slabs): size 6
- Used for anchorages in prestressed hollow core slabs: size 6

### Base materials:

- Compacted reinforced and compacted unreinforced concrete without fibers according to EN 206:2013.
- Strength classes C20/25 to C50/60 according to EN 206:2013.
- Cracked and uncracked concrete.

### Use conditions (Environmental conditions):

- Concrete screws subject to dry internal conditions: all screw types.
- Structural subject to external atmospheric exposure (including industrial and marine environment) and to permanently damp internal condition no particular aggressive conditions exists: screw types made of stainless steel with marking A4.
- Structural subject to external atmospheric exposure (including industrial and marine environment) and to permanently damp internal condition if particular aggressive conditions exists: screw types made of stainless steel with marking HCR.

Note: Such particular aggressive conditions are e.g. permanent, alternating immersion in seawater or splash zone of seawater, chloride atmosphere of indoor swimming pools or atmosphere with chemical pollution (e.g. in desulphurization plants or road tunnels where de-icing materials are used).

### Design:

- Anchorages are to be designed under the responsibility of an engineer experienced in anchorages and concrete work.
- Verifiable calculation notes and drawings are to be prepared taking account of the loads to be anchored. The position of the anchor is indicated on the design drawings (e.g. position of the anchor relative to reinforcement or to supports, etc.).
- Anchorages are designed according to EN 1992-4:2018 and EOTA Technical Report TR 055.
- The design for shear load according to EN 1992-4:2018, Section 6.2.2 applies for all specified diameters  $d_f$  of clearance hole in the fixture in Annex B2, Table 3.

### Installation:

- Hammer drilling or hollow drilling.
- Anchor installation carried out by appropriately qualified personnel and under the supervision of the person responsible for technical matters on site.
- In case of aborted hole: new drilling must be drilled at a minimum distance of twice the depth of aborted hole or closer, if the aborted hole is filled with high strength mortar and only if the hole is not in the direction of the oblique tensile or shear load.
- After installation further turning of the anchor must not be possible. The head of the anchor is supported in the fixture and is not damaged.

Ramset™ AnkaScrew™ Xtrem™

Intended use  
Specification

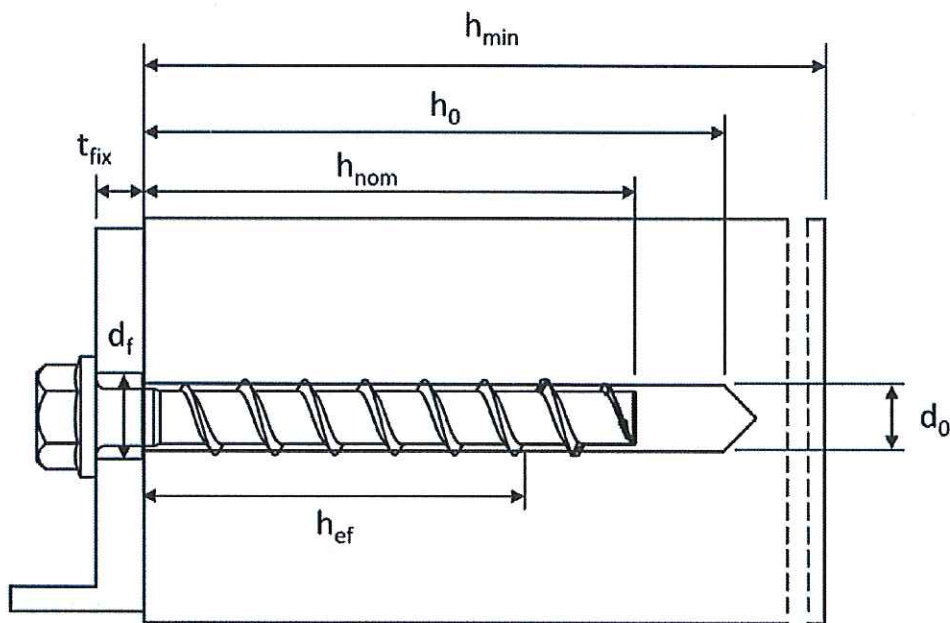
Annex B1

**Table 3: Installation parameters**

AnkaScrew Xtrem size			5	6	
Nominal embedment depth	$h_{nom}$		$h_{nom1}$	$h_{nom1}$	$h_{nom2}$
	[mm]		35	35	55
Nominal drill hole diameter	$d_0$	[mm]	5	6	
Cutting diameter of drill bit	$d_{cut} \leq$	[mm]	5,40	6,40	
Drill hole depth	$h_0 \geq$	[mm]	40	40	60
Clearance hole diameter	$d_f \leq$	[mm]	7	8	
Installation torque (version with connection thread)	$T_{inst} \leq$	[Nm]	8	10	
Recommended torque impact screw driver	[Nm]	Max. torque according to manufacturer's instructions			
		110	160		

**Table 4: Minimum thickness of member, minimum edge distance and minimum spacing**

AnkaScrew Xtrem size			5	6	
Nominal embedment depth	$h_{nom1}$		$h_{nom1}$	$h_{nom1}$	$h_{nom2}$
	[mm]		35	35	55
Minimum thickness of member	$h_{min}$	[mm]	80	80	100
Minimum edge distance	$c_{min}$	[mm]	35	35	40
Minimum spacing	$s_{min}$	[mm]	35	35	40

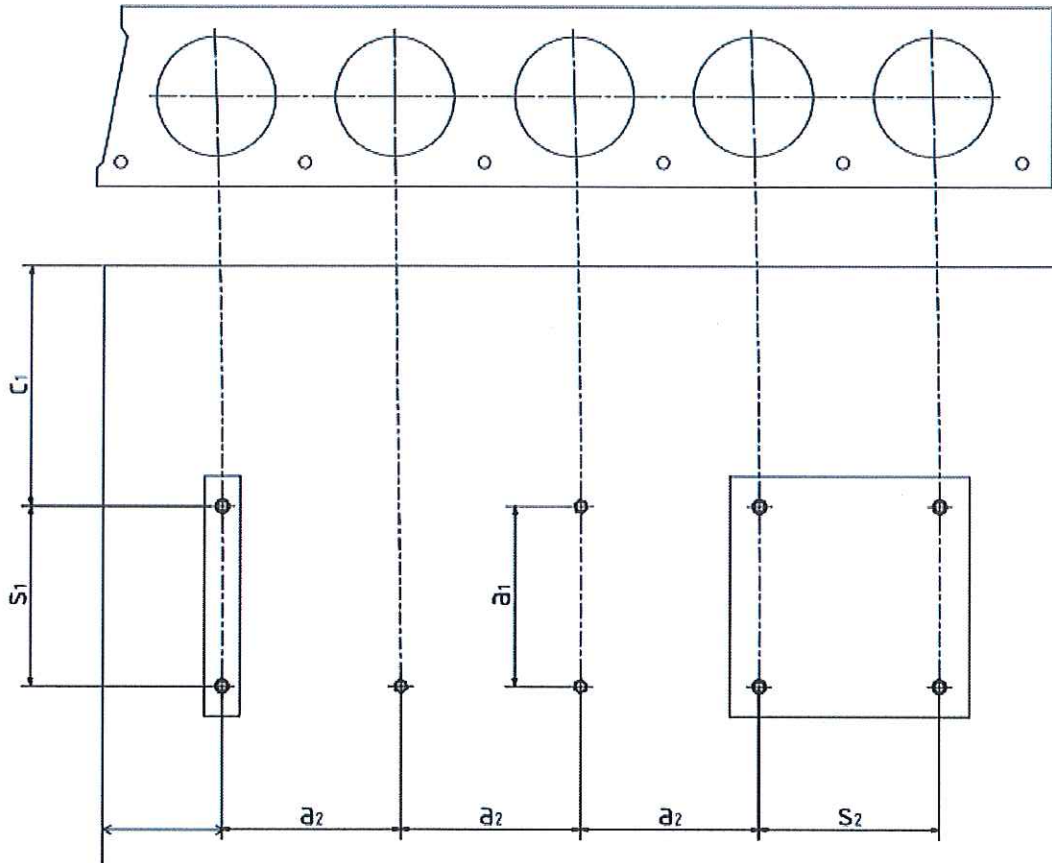


Ramset™ AnkaScrew™ Xtrem™

Intended use  
Installation parameters

Annex B2

**Installation parameters for anchorages in precast prestressed hollow core slabs**



$c_1, c_2$  = edge distance

$s_1, s_2$  = anchor spacing

$a_1, a_2$  = distance between anchor groups

$c_{min}$  = minimum edge distance  $\geq 100$  mm

$s_{min}$  = minimum anchor spacing  $\geq 100$  mm

$a_{min}$  = minimum distance between anchor groups  $\geq 100$  mm

**Ramset™ AnkaScrew™ Xtrem™**

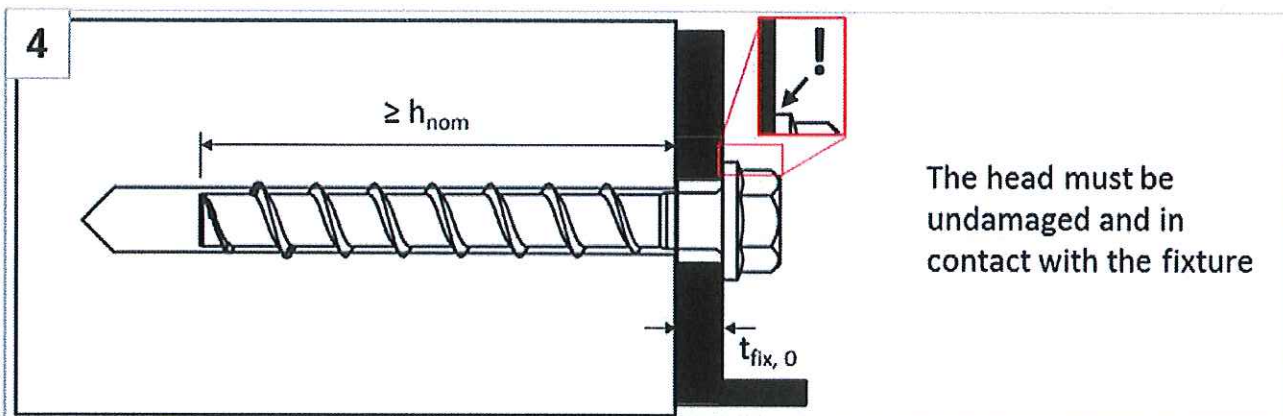
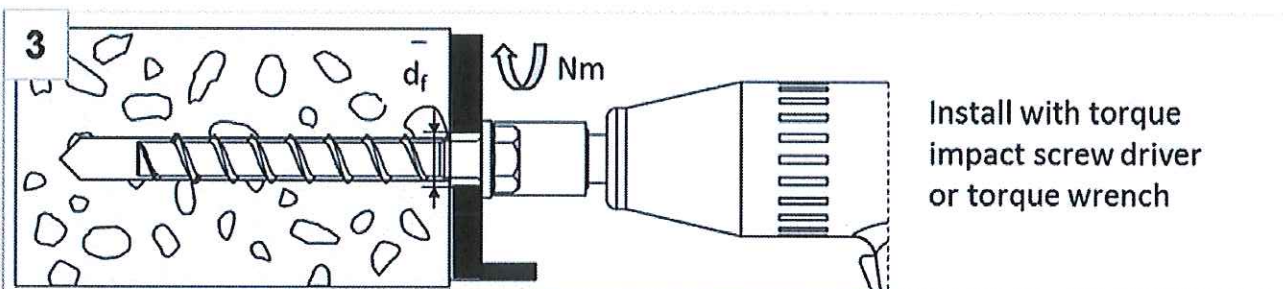
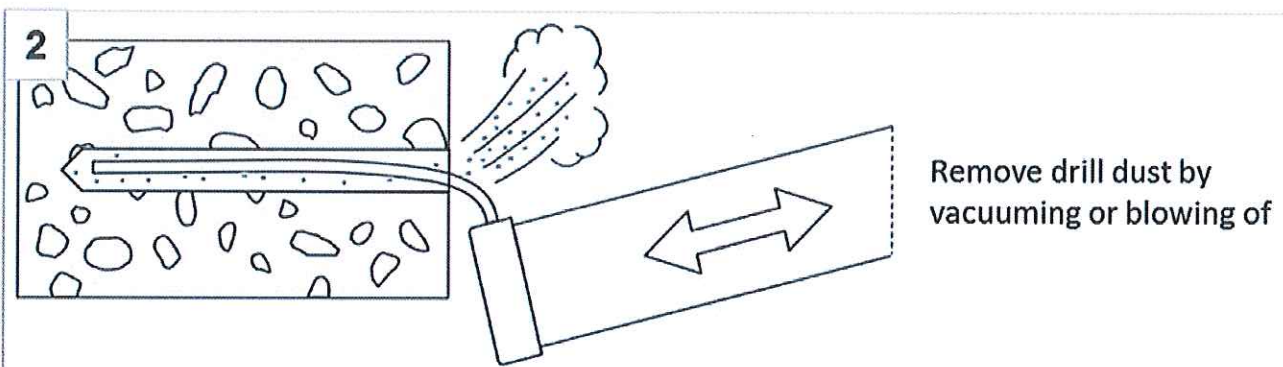
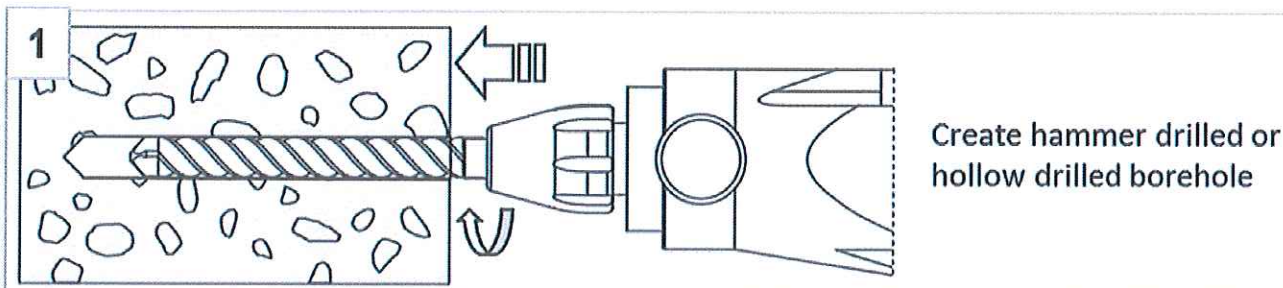
**Intended use**

Installation parameters for anchorages in precast prestressed hollow slabs

**Annex B3**



## Installation Instructions



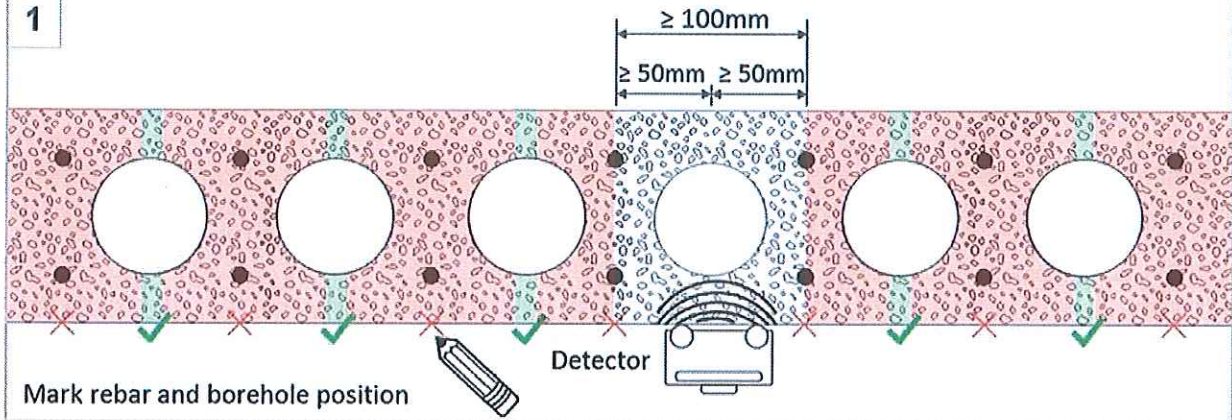
Ramset™ AnkaScrew™ Xtrem™

Intended use  
Installation instructions

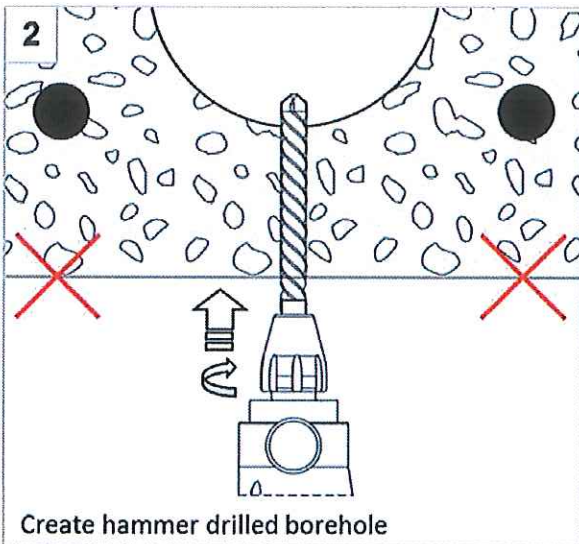
Annex B4

### Installation Instructions for anchorages in prestressed hollow slabs

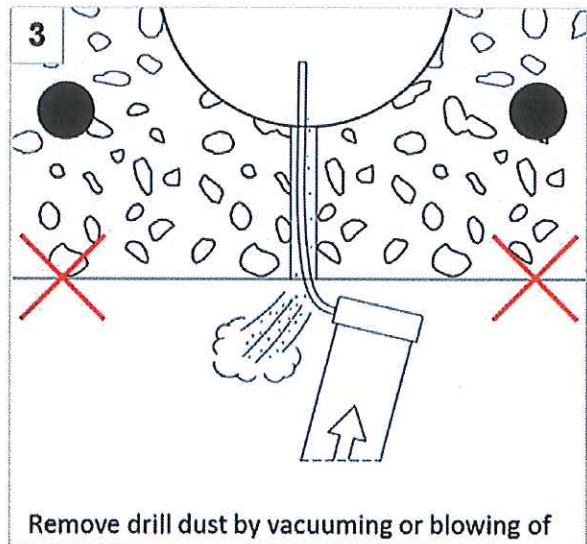
1



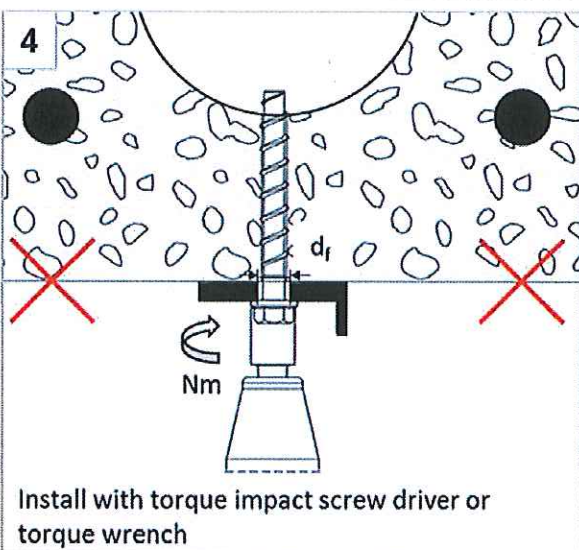
2



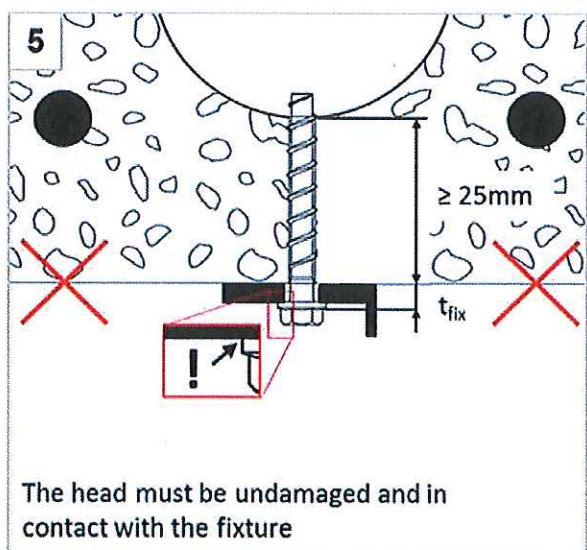
3



4



5



Ramset™ AnkaScrew™ Xtrem™

Intended use

Installation instructions for anchorages in prepressed hollow slabs

Annex B5



Table 5: Characteristic values for static and quasi-static loading

AnkaScrew Xtrem size			5	6		
Nominal embedment depth	$h_{nom}$	$h_{nom1}$	$h_{nom1}$	$h_{nom2}$		
	[mm]	35	35	55		
<b>Steel failure for tension and shear loading</b>						
Characteristic tension load	$N_{Rk,s}$	[kN]	8,7	14,0		
Partial factor	$\gamma_{Ms,N}$	[-]	1,5			
Characteristic shear load	$V_{Rk,s}^0$	[kN]	4,4	7,0		
Partial factor	$\gamma_{Ms,V}$	[-]	1,25			
Ductility factor	$k_7$	[-]	0,8			
Characteristic bending load	$M_{Rk,s}^0$	[Nm]	5,3	10,9		
<b>Pull-out failure</b>						
Characteristic tension load C20/25	cracked	$N_{Rk,p}$	[kN]	1,5	3,0	7,5
	uncracked	$N_{Rk,p}$	[kN]	1,5	3,0	7,5
Increasing factor for $N_{Rk,p}$	C25/30	$\Psi_c$	[-]	1,12		
	C30/37			1,22		
	C40/50			1,41		
	C50/60			1,58		
<b>Concrete failure: Splitting failure, concrete cone failure and pry-out failure</b>						
Effective embedment depth	$h_{ef}$	[mm]	27	27	44	
k-factor	cracked	$k_1 = k_{cr}$	[-]	7,7		
	uncracked	$k_1 = k_{ucr}$	[-]	11,0		
Concrete cone failure	spacing	$s_{cr,N}$	[mm]	3 x $h_{ef}$		
	edge distance	$c_{cr,N}$	[mm]	1,5 x $h_{ef}$		
Splitting failure	resistance	$N_{Rk,Sp}^0$	[kN]	$\min(N_{Rk,c}^0; N_{Rk,p})$		
	spacing	$s_{cr,Sp}$	[mm]	120	120	160
	edge distance	$c_{cr,Sp}$	[mm]	60	60	80
Factor for pry-out failure	$k_8$	[-]	1,0			
Installation factor	$\gamma_{inst}$	[-]	1,2	1,0	1,0	
<b>Concrete edge failure</b>						
Effective length in concrete	$l_f = h_{ef}$	[mm]	27	27	44	
Nominal outer diameter of screw	$d_{nom}$	[mm]	5	6		
<b>Ramset™ AnkaScrew™ Xtrem™</b>					<b>Annex C1</b>	
<b>Performances</b> Characteristic values for static and quasi-static loading						



**Table 6: Characteristic values of resistance in precast prestressed hollow core slabs C30/37 to C50/60**

AnkaScrew Xtrem size			6		
Bottom flange thickness	$d_b$	[mm]	$\geq 25$	$\geq 30$	$\geq 35$
Characteristic resistance	$F_{Rk}^0$	[kN]	1	2	3
Edge distance	$c_{cr}$	[mm]	100		
Spacing	$s_{cr}$	[mm]	200		
Installation factor	$\gamma_{inst}$	[-]	1,0		

**Table 7: Limiting distances for application in precast prestressed hollow core slabs**

Distances for application in precast prestressed hollow core slabs			
Minimum edge distance	$c_{min}$	[mm]	$\geq 100$
Minimum anchor spacing	$s_{min}$	[mm]	$\geq 100$
Minimum distance between anchor groups	$a_{min}$	[mm]	$\geq 100$
Distance of core	$l_c$	[mm]	$\geq 100$
Distance of prestressing steel	$l_p$	[mm]	$\geq 100$
Distance between anchor position and prestressing steel	$a_p$	[mm]	$\geq 50$

**Ramset™ AnkaScrew™ Xtrem™**

**Performances**

Characteristic values and limiting distances in precast prestressed hollow core slabs

**Annex C2**

Table 8: Fire exposure – characteristic values of resistance <sup>1)</sup>

AnkaScrew Xtrem size				6			
Material				AnkaScrew Xtrem		AnkaScrew Xtrem A4/HCR	
Nominal embedment depth		$h_{nom}$		$h_{nom1}$	$h_{nom2}$	$h_{nom1}$	$h_{nom2}$
		[mm]		35	55	35	55
Steel failure for tension and shear load ( $F_{Rk,s,fi} = N_{Rk,s,fi} = V_{Rk,s,fi}$ )							
Characteristic Resistance	R30	$F_{Rk,s,fi30}$	[kN]	0,9		1,2	
	R60	$F_{Rk,s,fi60}$	[kN]	0,8		1,2	
	R90	$F_{Rk,s,fi90}$	[kN]	0,6		1,2	
	R120	$F_{Rk,s,fi120}$	[kN]	0,4		0,8	
	R30	$M^0_{Rk,s,fi30}$	[Nm]	0,7		0,9	
	R60	$M^0_{Rk,s,fi60}$	[Nm]	0,6		0,9	
	R90	$M^0_{Rk,s,fi90}$	[Nm]	0,5		0,9	
	R120	$M^0_{Rk,s,fi120}$	[Nm]	0,3		0,6	

Pull-out failure							
Characteristic Resistance	R30-R90	$N_{Rk,p,fi}$	[kN]	0,75	1,875	0,75	1,875
	R120	$N_{Rk,p,fi}$	[kN]	0,6	1,5	0,6	1,5

Concrete cone failure							
Characteristic Resistance	R30-R90	$N^0_{Rk,c,fi}$	[kN]	0,86	2,76	0,86	2,76
	R120	$N^0_{Rk,c,fi}$	[kN]	0,68	2,21	0,68	2,21

Edge distance							
R30 - R120		$c_{cr,fi}$	[mm]	2 x $h_{ef}$			

In case of fire attack from more than one side, the minimum edge distance shall be  $\geq 300$ mm.

Spacing							
R30 - R120		$s_{cr,fi}$	[mm]	4 x $h_{ef}$			

Pry-out failure							
R30 - R120		$k_g$	[-]	1,0			

The anchorage depth has to be increased for wet concrete by at least 30 mm compared to the given value.

<sup>1)</sup> Not for application in prestressed hollow core slabs

<p><b>Ramset™ AnkaScrew™ Xtrem™</b></p> <p><b>Performances</b> Characteristic values under fire exposure</p>		<p><b>Annex C3</b></p>
--	--	------------------------