

OrbiPlate™ Fastener Connections



ITW Australia Pty. Ltd. T/A Ramset™

A founding board member of AEFAC



**Product Engineering
Laboratory**

Ramset Product Engineering Laboratory
Seismic shear testing has been performed by Swinburne University, an independent testing laboratory. All static testing has been performed by Melbourne Testing Services, a Nata accredited laboratory and the PEL, an ITW facility. See below for details.

Fastener Technical Assessment

FTA-22/0006
Of 05/07/2023

This Technical Assessment meets the requirements in accordance with
AS 4100:2020 (A1) cl 9.2.2.4, NZS 3404.1:1997 cl 9.3.2.4 & EOTA TR029 cl 2.3.3 (ACI 355.2 cl 9.6)

Trade name of the construction product

OrbiPlate™ Fastener Connections

Product family to which the construction product belongs

OrbiPlate™ structural connections for steel to steel and steel to concrete connections
ORB2016BGH, ORB2020BGH

Manufacturer

Ramset
1 Ramset Drive
Chirnside Park Victoria 3116
Australia

Manufacturing plant

Ramset™

This Technical Assessment contains

16 pages & 10 Annexes which form an integral part of this assessment.

This Technical Assessment has been conducted as per the provisions for standard bolted connections as required by the Australian and New Zealand Steel Structures Standards, AS 4100:2020 (A1) section 9.2.2.4 and NZS 3404.1:1997 section 9.3.2.4 and provisions for Seismic Shear as required by EOTA TR029:2016 cl 2.3.3 (ACI 355.2 cl 9.6)

Tests performed by,

- Swinburne University (SWUT),
- Melbourne Testing Services (MTS) and
- ITW Product Engineering Laboratory (PEL)

Reference reports:

- SWUT: Report Date November 2021
- MTS: MT-12/376 (2012)
- ITW PEL: ESRT1410 (2015)

OrbiPlate™ Fastener Connections

1. Technical description of the product

OrbiPlate™ is a proprietary bolted connection system which overcomes cumulative construction tolerances.

All OrbiPlate™ components in this report are steel elements consisting of a serrated orbital plate, toothed washer, and proprietary serrated flange head bolt. They can be used for steel to concrete connection with Reid footed ferrules or for steel to steel connections with class 8.8 nuts.

The illustration and the description of the product is given in Annex A.

2. Specification of intended use

The performances given in Section 3 are only valid if the Bolted Connection System is used in compliance with the specifications and conditions given in Annex B.

3. Performance of the product and references to the methods used for its assessment

3.1 Performance Requirement of OrbiPlate™ Connections

Criteria	Performance
Rotational & Longitudinal Shear Performance Steel to Concrete Connection AS 3600:2018 (A2) S.19, NZS 3101:2006 (A3) S.17, AS 4100:2020 (A1) and NZS 3404.1:1997	See Annex C1 (Table)
Rotational & Longitudinal Shear Performance Steel to Steel AS 4100:2020 (A1), NZS 3404.1:1997	See Annex C2 (Table)
Rotational & Longitudinal Seismic Shear Performance Steel to Steel AS 4100:2020 (A1), NZS 3404.1:1997, EOTA TR049 Seismic Category C1 (ACI 355.2) Seismic C1	See Annex C3 (Table)
Rotational & Longitudinal Shear Performance Steel to Steel AS 4100:2020 (A1), NZS 3404.1:1997	See Annex C4 (Graph)
Rotational & Longitudinal Seismic Shear Performance Steel to Steel AS 4100:2020 (A1), NZS 3404.1:1997, EOTA TR049 Seismic Category C1 (ACI 355.2) Seismic C1	See Annex C5 (Graph)
Tensile Performance Steel to Concrete Connections: ACI 318-M19 Chapter 17. Steel to Steel Connections (Bolted): AS 4100:2020 (A1) and NZS 3404.1:1997	See Annex C6 (Table)

OrbiPlate™ Fastener Connections

Testing Methodology of Mechanical Connections

OrbiPlate™ ORB2016BGH, ORB2020BGH Connection assemblies for Steel to Steel connections and Steel to concrete connections to be **fastened as per the installation guidelines**.

3.2.1 Rotational Shear Steel to Concrete Connections – AS 3600:2018 (A2), AS 4100:2020 (A1), NZS 3101:2006 (A3) and NZS 3404.1:1997

Configure test plates in the following way,

Set-up 1 (M20 & 16mm plate – slot aligned vertically & bolt central to washer)

- Cast Reid M20 Elephant foot ferrule into centre of concrete block in readiness for connection to a 16mm thick plate with a 70mm diam through hole and incorporating a welded lug to allow test rig draw bar attachment. Achieve connection using an ORB2020B with the slot vertically aligned and the bolt central to the washer.

Set-up 2 (M20 & 12mm plate – slot aligned vertically & bolt central to washer)

- Cast Reid M20 Elephant foot ferrule into centre of concrete block in readiness for connection to a 12mm thick plate with a 70mm diam through hole and incorporating a welded lug to allow test rig draw bar attachment. Achieve connection using an ORB2020B with the slot vertically aligned and the bolt central to the washer.

Set-up 3 (M20 & 6mm plate – slot aligned vertically & bolt central to washer)

- Cast Reid M20 Elephant foot ferrule into centre of concrete block in readiness for connection to a 6mm thick plate with a 70mm diam through hole and incorporating a welded lug to allow test rig draw bar attachment. Achieve connection using an ORB2020B with the slot vertically aligned and the bolt central to the washer.

Set-up 4 (M20 & 12mm plate – slot horizontally aligned and bolt at extremity)

- Cast Reid M20 Elephant foot ferrule into centre of concrete block in readiness for connection to a 12mm thick plate with a 70mm diam through hole and incorporating a welded lug to allow test rig draw bar attachment. Achieve connection using an ORB2020B with the slot horizontally aligned and the bolt at the extremity of slot.

Set-up 5 (M16 & 6mm plate – slot horizontally aligned and bolt at extremity)

- Cast Reid M16 Elephant foot ferrule into centre of concrete block in readiness for connection to a 6mm thick plate with a 70mm diam through hole and incorporating a welded lug to allow test rig draw bar attachment. Achieve connection using an ORB2016B with the slot vertically aligned and the bolt central to the washer.

Set-up 6 (M16 & 12mm plate – slot horizontally aligned and bolt at extremity)

- Cast Reid M16 Elephant foot ferrule into centre of concrete block in readiness for connection to a 12mm thick plate with a 70mm diam through hole and incorporating a welded lug to allow test rig draw bar attachment. Achieve connection using an ORB2016B with the slot vertically aligned and the bolt central to the washer.

Conduct test for each set-up by attaching draw bar to lug with displacement extensometer. Apply tensile force at a constant rate and continue until the onset of bolt shear or rupture of the OrbiPlate washer is evident. Test data, including applied force and test displacement, to be recorded autographically throughout the test.

Note: Consideration should also be given to performance of concrete in bearing and of bolt + ferrule insert bending when assessing the test results.

OrbiPlate™ Fastener Connections

3.2.2 Rotational Shear Performance Steel to Steel – AS 4100:2020 (A1) & NZS 3404.1:1997

Configure test plates in the following way,

- One 20mm plate with an M20 tapped hole mated to a 16mm thick plate with a 70mm diam through hole. Achieve connection using an ORB2020B OrbiPlate with the slot horizontally aligned and the bolt at the extremity of slot.

Conduct test by gripping each end of the test plates between pinned clevis test fixtures. Apply tensile force at a constant rate and continue until the onset of bolt shear, rupture of the OrbiPlate washer or failure of one of the connection plates is evident. Test data, including applied force and test displacement, to be recorded autographically throughout the test.

3.2.3 Longitudinal Shear Performance Steel to Steel – AS 4100:2020 (A1) & NZS 3404.1:1997

Configure test plates in the following way,

- One 20mm plate with an M20 tapped hole mated to a 16mm thick plate with a 70mm diam through hole. Achieve connection using an ORB2020B OrbiPlate with the slot vertically aligned upwards and the bolt central to the OrbiPlate washer.

Conduct test by gripping each end of the test plates between pinned clevis test fixtures. Apply tensile force at a constant rate and continue until the onset of bolt shear, rupture of the OrbiPlate washer or failure of one of the connection plates is evident. Test data, including applied force and test displacement, to be recorded autographically throughout the test.

3.2.4 Longitudinal Seismic Shear Performance Steel to Steel – AS 4100:2020 (A1), NZS 3404.1:1997, EOTA TR049 Seismic Category C1 (ACI 355.2)

Configure test plates in the following way,

- For the M20 Bolted OrbiPlate System, mate a reaction plate to a 16mm thick plate with a 70mm diam through hole. Achieve connection using an ORB2020BGH with the slot vertically aligned upwards and locating the bolt 10mm off centre (half-way of the slot). Ensure bolt is fastened through the assembly by using a corresponding nut and with a torque level suited to the system.
- For the M16 Bolted OrbiPlate system, mate a reaction plate to a 12mm thick plate with a 70mm diam through hole. Achieve connection using an ORB2016BGH with the slot vertically aligned upwards and locating the bolt 10mm off-centre (half-way of the slot). Ensure bolt is fastened through the assembly by using a corresponding nut and with a torque level suited to the system.

Conduct test by gripping each end of the test plates between pinned clevis test fixtures. Apply force to the system and commence cyclic shear loading protocol in accordance with TR049 clause 2.3.3. After completion of cyclic shear protocol, test assembly to failure in shear. Test data, including applied force and test displacement, to be recorded autographically throughout the test.

3.2.5 Rotational Seismic Shear Performance Steel to Steel – AS 4100:2020 (A1), NZS 3404.1:1997, EOTA TR049 Seismic Category C1 (ACI 355.2)

Configure test plates in the following way,

- For the M20 Bolted OrbiPlate System, mate a reaction plate to a 6mm thick plate with a 70mm diam through hole. Achieve connection using an ORB2020BGH with the slot horizontally aligned and the bolt positioned 20mm off-centre (outer-most position on the slot). Ensure bolt is fastened through the assembly by using a corresponding nut and with a torque level suited to the system.

Conduct test by gripping each end of the test plates between pinned clevis test fixtures. Apply force to the system and commence cyclic shear loading protocol in accordance with TR049 clause 2.3.3. After completion of cyclic shear protocol, test assembly to failure in shear. Test data, including applied force and test displacement, to be recorded autographically throughout the test.

4 Material Safety Data Sheet (N/A).

OrbiPlate™ Fastener Connections

OrbiPlate™ Connections
ORB2016BGH, ORB2020BGH



OrbiPlate™

Ferrule size, d _b	Washer OD (mm)	Fixture Hole ø (mm)	Bolt	Hex Head AF (mm)	Part No. Gal
M16	80	70 ± 1	M16 x 50	30	ORB2016BGH
M20	80	70 ± 1	M20 x 60	30	ORB2020BGH

Ferrules

Ferrule size, d _b	Ferrule OD (mm)	Ferrule length, L (mm)	Effective depth, h (mm)	Thread length, L _t (mm)	Cross hole to suit	Part No. Gal
M16	22	95	91	32	N12	FE16095GH
M20	26	95	91	38	N12	FE20095GH
M20	30	75	70	32	N12	TIM20x75G (NZ Only)

OrbiPlate™ Connection assemblies

Product description
Mechanical connection (Steel to Steel or Steel to Concrete)

Annex A 1

OrbiPlate™ Fastener Connections

OrbiPlate™ and Reid Footed Ferrules Engineering Properties M16, M20

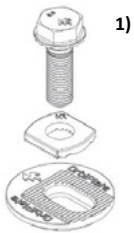

Size	Bolt Stress area (mm ²) ²⁾	Minor Bolt area (mm ²) ³⁾	Yield Strength, f_y (MPa)	Ult Strength, f_u (MPa)	Hex Head A/F (mm)	Section Modulus, Z (mm ³)
M16	157	144	664	830	30	277.5
M20	245	225	664	830	30	540.9

Notes:

- 1) Used for Steel to Steel or Steel to Concrete Connections
- 2) Used for tensile calculation as per NZS 3404 cl 9.3.2.2 and AS 4100 cl 9.2.2.2
- 3) Used for shear calculation as per NZS 3404 cl 9.3.2.1 and AS 4100 cl 9.2.2.1



Reid™ Footed Ferrules

Part Number	Ferrule size, d_b	Stress area threaded section, A_s (mm ²)	Carbon Steel		Section modulus, Z (mm ³)
			Yield strength, f_y (MPa)	Ult Strength f_u (MPa)	
FE16095GH	M16	158.0	400	500	692.8
FE20095GH	M20	242.0	400	500	1034.0
TIM20x75G (NZ Only)	M20	263.4	240	400	3174.0

Notes:

- 4) Used for Steel to Concrete Connections only

OrbiPlate™ and Reid Footed Ferrules Engineering Properties

Product description
OrbiPlate™ and Reid Footed Ferrules

Annex A 2

OrbiPlate™ Fastener Connections

Specifications of intended use

Anchorage subject to:

- Static and quasi-static load.
- Seismic load

Base materials

Steel to Concrete Connections

- Non-cracked and cracked concrete for bolted connections M16, M20
- Reinforced or unreinforced normal weight concrete for use in construction in accordance with AS 3600:2018 (A2) or NZS 3101:2006 (A3).

Steel to Steel Connections

- Steel Plate 6mm to 16mm Fixture Thickness for bolted connections M20
- Steel Plate 6mm to 12mm Fixture Thickness for bolted connections M16
- Structural steel for use in construction in accordance with AS 4100:2020 (A1) or NZS 3404.1:1997.

Design:

Steel to Concrete Connections

- Mechanical anchorage connections are designed in accordance with NZS 3101:2006 (A3) S17 or ACI 318M-19 Chapter 17 under the responsibility of an engineer experienced in structural design and concrete work.
- Verifiable calculation notes and drawings are prepared taking into account the loads to be anchored. The position of the anchor or connection is indicated on the design drawings.

Steel to Steel Connections

- Structural Steel connections are designed in accordance with AS 4100:2020 (A1) or NZS 3404.1:1997 under the responsibility of an engineer experienced in structural design in steel structures.

Installation:

- Installation carried out by appropriately qualified personnel and under the supervision of the person responsible for technical matters of the site.

ReidBarTX™ Components	
Intended use Specifications	Annex B 1

OrbiPlate™ Fastener Connections

Installation Procedure

1. Steel to Concrete Connections

Anchor Size (mm)	OrbiPlate™ Part Number	Ferrule Part Number	Fixture hole dia (mm)	Tightening Torque, T (Nm)	Optimum dimensions *		Fixture thickness (mm)
					Edge Distance, e _c (mm)	Anchor spacing, s _c (mm)	
M16	ORB20168GH	FE16095GH	70 ± 1	94	135	270	6
							8
							10
							12
M20	ORB20208GH	FE20095GH	70 ± 1	180	135	270	6
							10
							12
							16
M20	ORB20208GH	TIM20x75G with nail plate (NZ Only)	70 ± 1	144	105	210	6
							8
							12
							16

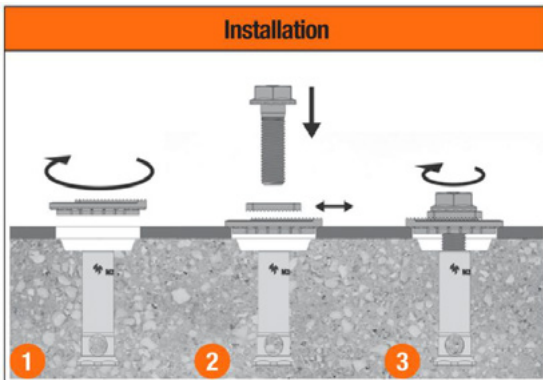
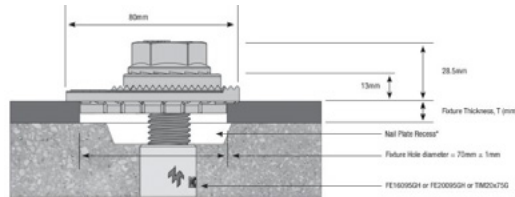

- Step 1 (TWIST IT)**
Place the large washer in the 70mm fixture hole and rotate until the slot lines up with the ferrule.
- Step 2 (SLIDE IT)**
Move small washer along slot until it aligns with ferrule.
- Step 3. (FIX IT)**
Insert the bolt and tighten to specified torque.

2. Steel to Steel Connections

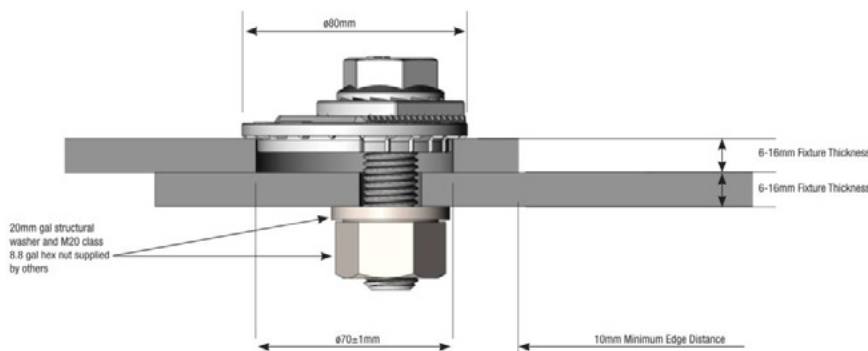

ReidBarTX™ Steel Couplers

Intended use
Installation procedure

Annex B 2

OrbiPlate™ Fastener Connections

Table C1: Rotational & Longitudinal Shear Performance Steel to Concrete Connections

AS 3600:2018 (A2) S.19, NZS 3101:2006 (A3) S.17, AS4100:2020 (A1) and NZS 3404.1:1997

OrbiPlate ²⁾ Part No.	Reid Footed Ferrule Part No.	No. (of samples tested)	Bolt orientation and alignment	Plate Thickness t [mm]	Mean Test Results			Test report reference [ITW]
					Mode of Failure [MoF]	Shear Load Ultimate V _{us} [kN]	Peak Displacement Δd [mm]	
ORB2020BGH	FE20095	3	Vertically aligned bolt central	16	Bolt/Bending	65.8	4.6	ESRT1410
ORB2020BGH	FE20095	3	Vertically aligned bolt central	12	Bolt/Bending	68.0	3.9	ESRT1410
ORB2020BGH	FE20095	3	Vertically aligned bolt central	6	Bolt/Bending	69.1	4.0	ESRT1410
ORB2020BGH	FE20095	3	Horizontally aligned bolt offset extremity	12	Bolt/Bending	74.1	4.1	ESRT1410
ORB2016BGH	FE16095	1 ¹⁾	Vertically aligned bolt central	6	Bolt/Bending	72.9	4.7	ESRT1410
ORB2016BGH	FE16095	3	Vertically aligned bolt central	12	Bolt/Bending	60.2	3.9	ESRT1410

Notes:

- 1) Tested 3 samples however data for 2 samples the transducers were damaged and therefore unable to read data.
- 2) The tested OrbiPlate components had a bright zinc coated finish

OrbiPlate™ Connection System (Steel to Concrete)

Performances: Shear under static force (Table)

According to AS 3600:2018 (A2) S.19, NZS 3101:2006 (A3) S.17, AS 4100:2020 (A1) and NZS 3404.1:1997

Annex C1

OrbiPlate™ Fastener Connections

Table C2: Rotational & Longitudinal Shear Performance Steel to Steel

AS 4100:2020 (A1), NZS 3404.1:1997

OrbiPlate ¹⁾ Part No.	Orientation Type	No. (of samples tested)	Bolt orientation and alignment	Plate Thickness t [mm]	Mean Test Results			Test report reference [MTS]
					Mode of Failure [MoF]	Shear Load Ultimate V _{us} [kN]	Peak Slip Displacement Δd [mm]	
ORB2020B	Longitudinal	3	Vertically aligned upwards bolt central	16	Steel serrated tooth washer	101.4	4.8	MT-12/376-3
ORB2020B	Longitudinal	3	Vertically aligned downwards bolt at extremity of slot	16	Steel/bolt shear	132.5	3.0	MT-12/376-4
ORB2020B	Rotational	3	Horizontally aligned and bolt at extremity of slot	16	Steel/bolt shear	116.5	0.8	MT-12/376-5a

Notes:

- 1) The tested OrbiPlate components had a bright zinc coated finish
- 2) For load displacement graphs refer to annex C4.

OrbiPlate™ Connection System (Steel to Steel)

Performances: Shear under static force (Table)
According to AS 4100:2020 (A1) and NZS 3404.1:1997

Annex C2

OrbiPlate™ Fastener Connections

Table C3: Rotational & Longitudinal Seismic Shear Performance Steel to Steel

AS 4100:2020 (A1), NZS 3404.1:1997, EOTA TR049 Seismic Category C1 (ACI 355.2)⁴⁾ Seismic C1

Residual Shear Capacity

OrbiPlate Part No.	Orientation Type	No. of samples tested	Bolt orientation and alignment	Plate Thickness t [mm]	Mean Test Results			Seismic Load Shear V _{eq} [kN]	Ratio of V _{res,m} /V _{eq} ¹⁾	Test report reference [SWUT]
					Mode of Failure [MoF]	Average residual shear capacity V _{res,m} [kN]	Peak Displacement ²⁾ Δd [mm]			
ORB2016BGH	Longitudinal	5	Vertically aligned upwards bolt central	12	Steel serrated tooth washer	71.1	4.9	27.6	2.6	SWUT-Report Date November 2021
ORB2020BGH	Longitudinal	5	Vertically aligned upwards bolt central	16	Steel serrated tooth washer	91.8	5.2	36.39	2.5	SWUT-Report Date November 2021
ORB2020BGH	Rotational	5	Horizontally aligned and bolt at extremity of slot	6	Steel/bolt shear	150.8	5.7	36.9	4.1	SWUT-Report Date November 2021

Notes:

- 1) Capacity Reduction Factor for Seismic C1 for the stated orientations is $\alpha_{V,C1} = 1.0$ if $V_{res,m}/V_{eq} \geq 1.6$
- 2) Average displacements are derived from graphs in Swinburne University Report Date November 2021
- 3) For Cyclic Shear tests graphs, refer to Annex C6
- 4) The C1 seismic shear testing protocol in EOTA TR049 is equivalent to the seismic shear testing protocol in ACI 355.2

OrbiPlate™ Connection System (Steel to Steel)

Performances: Shear under seismic force (Table)
According to AS 4100:2020 (A1), NZS 3404.1:1997, EOTA TR049 Cat.C1

Annex C3

OrbiPlate™ Fastener Connections

Graph C4: Rotational & Longitudinal Shear Performance Steel to Steel

**Shear Load vs Displacement Curve ORB2020B Longitudinal Vertically aligned upwards bolt central
16mm plate thickness, M20 bolt**

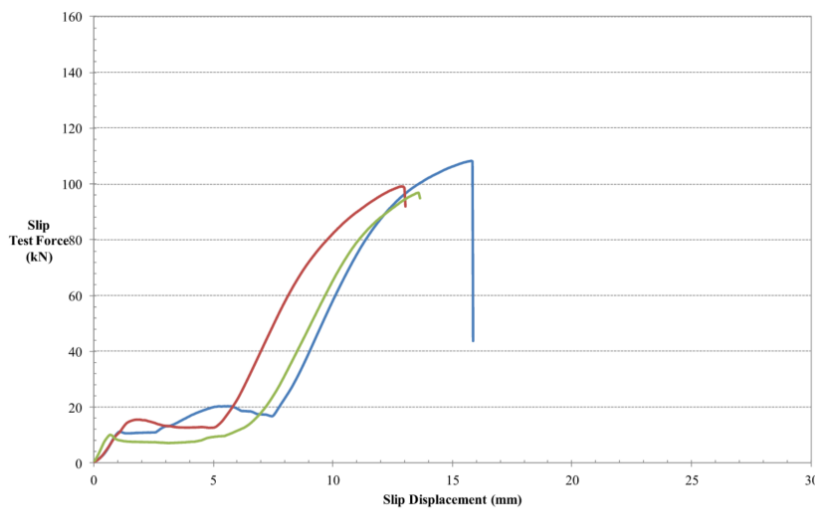

FIG.3C

Shear Load vs Displacement Curve ORB2020B Longitudinal Vertically aligned downwards bolt at extremity of slot 16mm plate thickness, M20 bolt

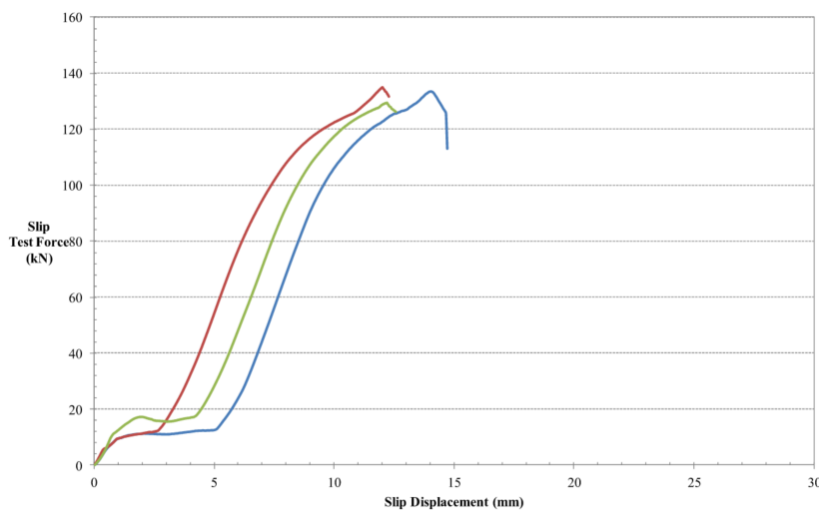

FIG.3D

OrbiPlate™ Connection System (Steel to Steel)

Performances: Shear under static force (Graph)
According to AS 4100:2020 (A1) and NZS 3404.1:1997

Annex C4

OrbiPlate™ Fastener Connections

Graph C4: Rotational & Longitudinal Shear Performance Steel to Steel (Graph)

Shear Load vs Displacement Curve ORB2020B Rotational Horizontally aligned and bolt at extremity of slot
16mm plate thickness, M20 bolt

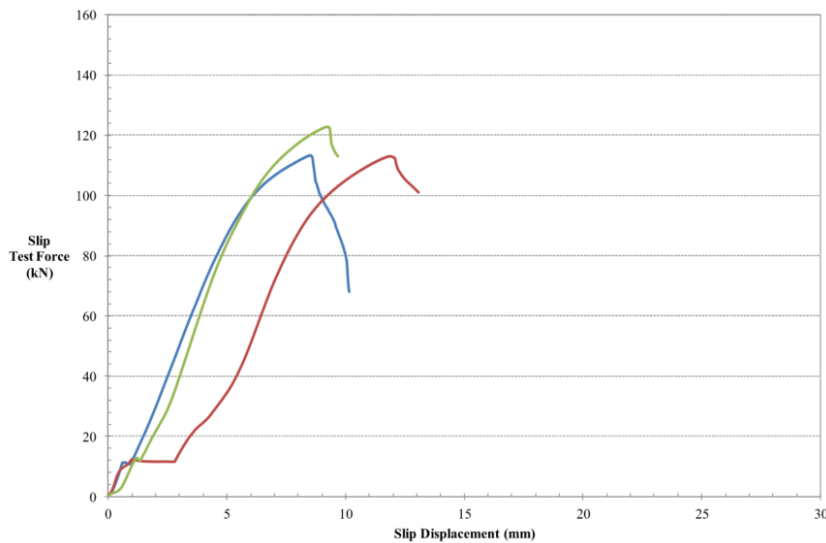

FIG 3E

OrbiPlate™ Connection System (Steel to Steel)

Performances: Shear under static force (Graph)
According to AS 4100:2020 (A1) and NZS 3404.1:1997

Annex C4

OrbiPlate™ Fastener Connections

Graph C5: Rotational & Longitudinal Seismic Shear Performance Steel to Steel

**Cyclic Loading for ORB2016BGH Longitudinal Vertically aligned upwards bolt central
12mm plate thickness, M16 bolt**

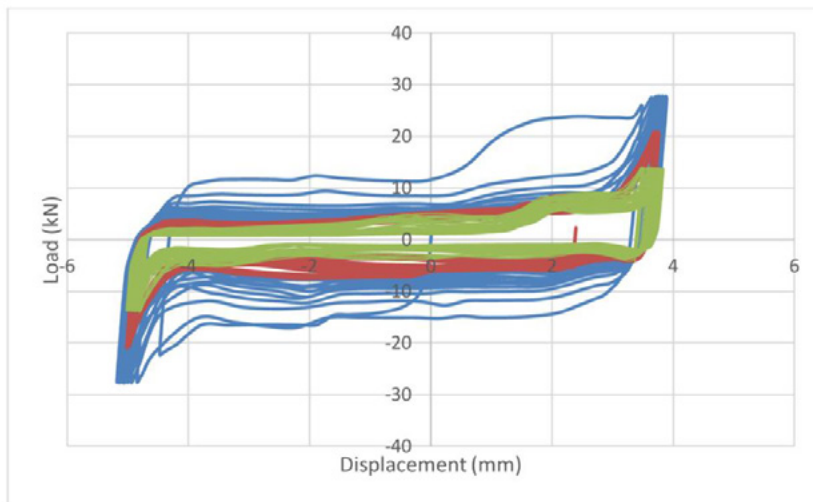

**Cyclic Loading for ORB2020BGH Longitudinal Vertically aligned upwards bolt central
16mm plate thickness, M20 bolt**

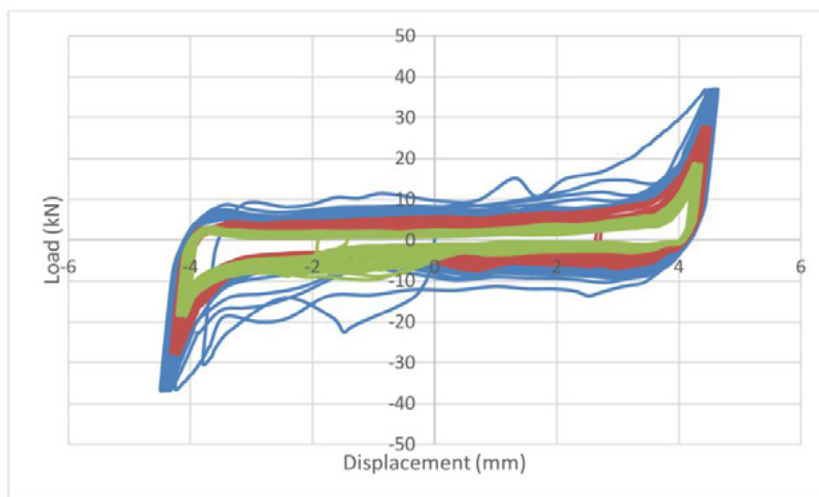

OrbiPlate™ Connection System (Steel to Steel)

Performances: Shear under seismic force (Graph)

According to AS 4100:2020 (A1), NZS 3404.1:1997, EOTA TR049 Cat.C1

Annex C 5

OrbiPlate™ Fastener Connections

Graph C5: Rotational & Longitudinal Seismic Shear Performance Steel to Steel

**Cyclic Loading for ORB2020BGH Rotational Horizontally aligned and bolt at extremity of slot
6mm plate thickness, M20 bolt**

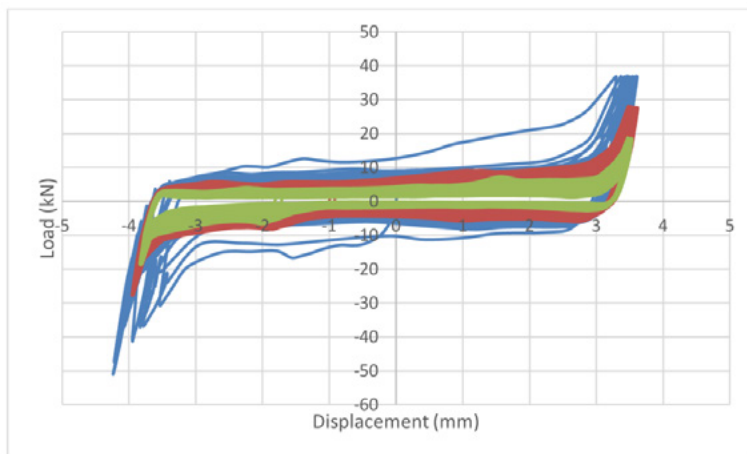

OrbiPlate™ Connection System (Steel to Steel)
Performances: Shear under seismic force (Graph)
 According to AS 4100:2020 (A1), NZS 3404.1:1997, EOTA TR049 Cat.C1

Annex C5

OrbiPlate™ Fastener Connections

Table C6: Tensile Performance

Concrete Tensile to ACI 318-M19 Chapter 17

OrbiPlate Part No.	Reid Footed Ferrule Part No.	Effective Depth h_{ef} [mm]	Metric Size & Bolt Length [mm]	Tensile Capacity (kN) for Concrete where $f'_c = 20$ MPa				Capacity Reduction Factor ϕ	CCD Model for Characteristic Cracked Concrete Tensile Capacity [ACI 318] ¹⁾
				Characteristic Ultimate Tensile Capacity TESTED Uncracked Concrete $N_{uc,test}$ [kN]	Characteristic Ultimate Tensile Capacity CCD Cracked Concrete $N_{uc,crk}$ [kN]	Characteristic Ultimate Tensile Capacity CCD Seismic C1 ³⁾ Cracked Concrete ²⁾ $N_{uc,seis}$ [kN]			
ORB2016BGH	FE16095GH	91	M16 x 50	56.5	38.8	29.1	0.6	$N_{uc,crk} = N_b = k \cdot \sqrt{f'_c} \cdot h_{ef}^{1.5}$	
ORB2020BGH	FE20095GH	91	M20 x 60	63.1	38.8	29.1	0.6	$N_{uc,crk} = N_b = k \cdot \sqrt{f'_c} \cdot h_{ef}^{1.5}$	
ORB2020BGH	TIM20x75G (NZ only)	70	M20 x 60	55	26.2	19.6	0.6	$N_{uc,crk} = N_b = k \cdot \sqrt{f'_c} \cdot h_{ef}^{1.5}$	

Notes:

- 1) $k = 10$ for cracked concrete
- 2) Seismic capacity reduction factor $\alpha_{seis} = 0.75$ is included against the Cracked Concrete Tensile Capacity using CCD model
- 3) Seismic tension C1 is based on EOTA TR049 clause 2.3.2 which is equivalent to Seismic tension ACI 355.2 clause 9.5

Steel Tensile to AS 4100:2020 (A1) and NZS 3404.1:1997

OrbiPlate ²⁾ Part No.	Reid Footed Ferrule ¹⁾ Part No.	Metric Size & Bolt Length [mm]	Tensile Capacity (kN) for Steel			
			Characteristic Ultimate Steel Tensile Capacity of Ferrule $N_{us,fer}$ [kN]	Characteristic Ultimate Steel Tensile Capacity of OrbiPlate/Bolt $N_{us,orb}$ [kN]	Capacity Reduction Factor Seismic Tension α_{seis}	Capacity Reduction Factor ϕ
ORB2016BGH	FE16095GH	M16 x 50	79.0	130.3	1.0	0.8
ORB2020BGH	FE20095GH	M20 x 60	121.0	203.4 ²⁾	1.0	0.8
ORB2020BGH	TIM20x75G (NZ only)	M20 x 60	105.3	203.4 ²⁾	1.0	0.8

Notes:

- 1) For Steel to Concrete Connections use only Reid Footed Ferrules with OrbiPlate and Metric Bolt as system
- 2) For Steel to Steel Connections use only ORB2020BGH with M20 bolt as system

OrbiPlate™ Connection System (Steel to Steel and Steel to Concrete)

Performances: Tensile under static & seismic force (Table)
 Concrete Tensile: According to ACI 318-M19 (A3) Chapter 17
 Steel Tensile: According to AS 4100:2020 (A1) and NZS 3404.1:1997

Annex C6

For further information, please contact Ramset™
AU - PHONE: 1300 780 063 www.ramset.com.au
NZ - PHONE: 1800 RAMSET (726738) www.ramset.co.nz