

ReidBraceTM

Design Guide

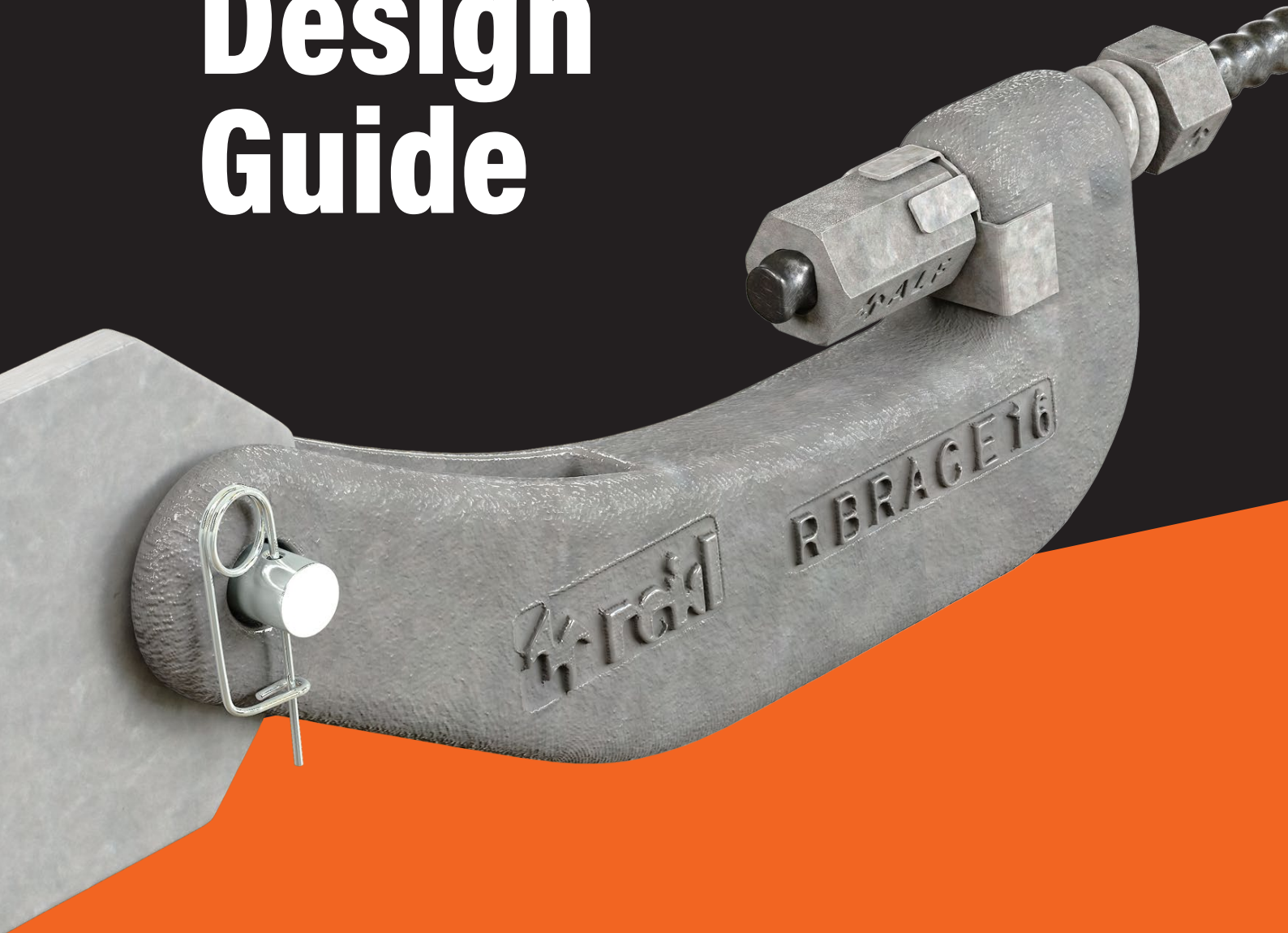

For more information on our products call
1300 780 063
or go on www.ramset.com.au





ReidBrace™

Engineered Bracing System

ReidBrace™ is an off the shelf, out of the box system that provides design engineers and installers with an economic solution for tension bracing of structures, tie-back applications, retrofits and temporary works bracing with proven performance.

ReidBrace™ utilises ReidBar™, a user friendly continuously threaded 500 grade reinforcing bar as the tension member. ReidBrace™ is a unique system that is as easy as screwing on a thread to install, minimising fabrication time.

Seismic Performance

ReidBrace™ has been tested and validated for Seismic Performance through an extensive test program at the University of Auckland's Structural Test Labs and at the Melbourne Testing Services NATA Accredited Laboratory. The test results have been assessed by Swinburne University providing a recommendation on the most appropriate seismic design parameters.

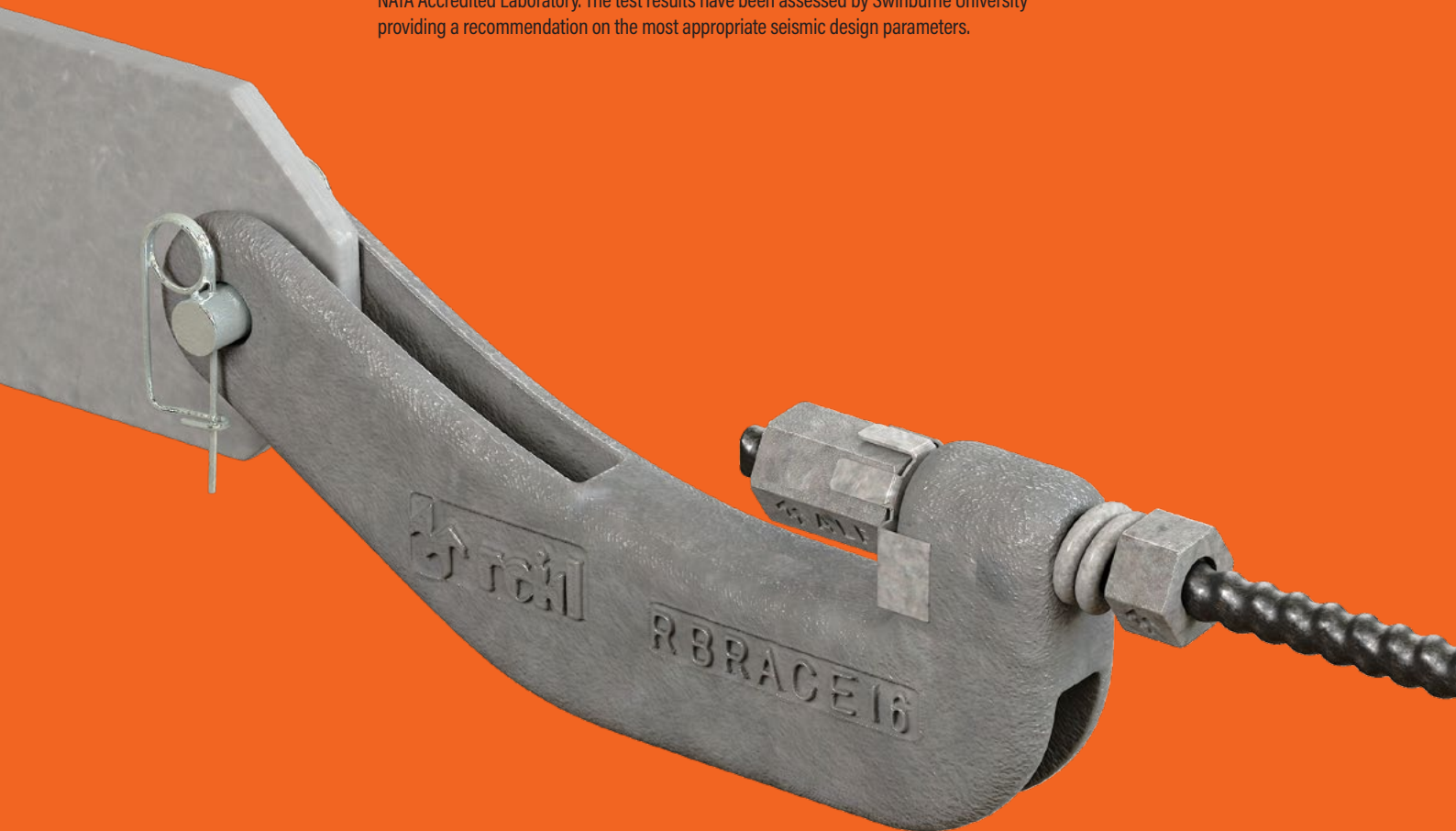

ReidBrace™

Boxed Set contents

ReidBrace™ Boxed Set Contents

1. Reid™ Tension Spring
2. Reid™ Tab Washer
3. RBRACE
4. RBRACE-END
5. ReidBar™ nut x 2
6. Pin and Clip

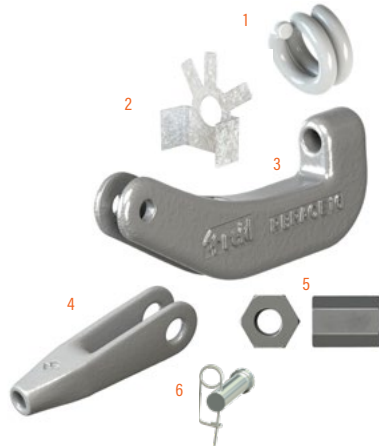

ReidBrace™ Boxed Set Kit Codes

Bar Size	Finish*	Kit Code
12mm	Galvanised	RBRACE12-SET
16mm	Galvanised	RBRACE16-SET
20mm	Galvanised	RBRACE20-SET(A)
25mm	Galvanised	RBRACE25-SET
32mm	Galvanised	RBRACE32-SET

Typical Applications



Tension Bracing

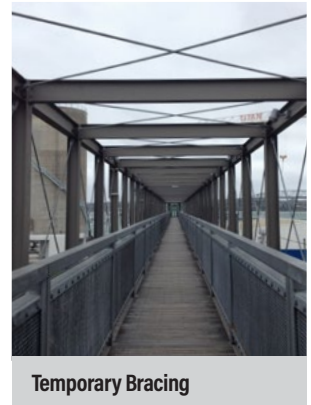

Temporary Bracing



Wall Panel Tie-back



Retrofit strengthening

ReidBrace™

✔ Benefits, Advantages and Features

Performance Tested

- ReidBrace™ has been performance tested as a system at the University of Auckland's Structural Test Labs and Melbourne Testing Services (a NATA Accredited Laboratory).

Simple to Design

- No welding nor custom design of bracing element. Furthermore, Ramset™ provides recommendations on steel cleat connection design.

Quality assured products

- ReidBrace™'s banana fittings, end fittings and nuts are manufactured to ASTM A536 Grade 100-70-03 / ISO 1083 Grade 600-3 SG Iron by ISO 9001 accredited manufacturer.
- ReidBrace™ load bearing components are tensile tested to destruction at Ramset™ facility.

Trusted ReidBar™ Tension Rod

- ReidBrace™ utilises the 500N ReidBar™ reinforcing rod. Widely recognised and readily available in the market, ReidBar™ is locally manufactured by ACRS certified Infrabuild to AS/NZS 4671.

Ease of Installation

- ReidBrace™ comes off the shelf in boxed sets, complete with step by step installation procedure.



Design Data ReidBrace™



ReidBrace™



ReidBrace™ End

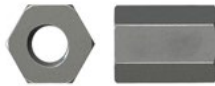

ReidBar™ Nut



ReidBar™

Tensile Capacities (ReidBrace™ System) - kN

ϕN_t = Limit State Design of System (Yield Theory) where $\phi = 0.9$

Size	ReidBar™		ReidBrace™ System (ReidBar™ & Components)			
	Min Yield Strength - f_y (kN)	Min Ultimate Strength- f_u (kN)	Design Capacity** (ϕN_t) per brace	Seismic Design Parameters***		Test Report Number/Date*
				Maximum Ductility Factor Max μ_{des}	Structural Performance Factor (S_p)	
12mm	56.5	61.0	47.0	1.5	0.7	MTS - 21-1064 & UoA - 25/05/18
16mm	100.6	108.5	83.0	1.5	0.7	MTS - 21-1064 & UoA - 25/05/18
20mm	157.0	169.6	130.0	1.5	0.7	MTS - 21-1064 & UoA - 25/05/18
25mm	245.5	265.1	203.0	1.5	0.7	MTS - 21-1064 & UoA - 25/05/18
32mm	402.0	434.2	332.0	1.0	-	MTS - 21-1064

*Note: Tested at University of Auckland (UoA) and Melbourne Testing Services (MTS) as per AS 4100:2020 clause 17.5 & AS/NZS 1170.0:2002 Appendix B

**Note: The Recommended Design Capacity is derived from nominal section capacity of a tension member as per AS 4100:2020 clause 7.2

***Note: Maximum Ductility Factor and Structural Performance Factor is based on Swinburne University Recommendation dated 20th June 2022

ReidBrace™

Design Data

Equivalent Elastic Modulus

Diameter	Equivalent elastic modulus
12mm	160,000MPa
16mm	145,000MPa
20mm	140,000MPa
25mm	135,000MPa

Test data has shown that the stiffness of the ReidBrace™ System is different from the theoretical Young's Modulus of steel; in order to obtain more realistic results from the FEM model, it is recommended to adopt the proposed Equivalent Elastic Modulus.

Ply in Bearing Design Recommendations

The following ply in bearing dimension recommendations have been derived using the design method outlined in AS 4100:2020 clause 9.2.2.4. The recommended cleat thickness (thickness of ply) and bolt/pin hole edge distance will be applicable for Steel Plate Grades greater or equal to 250 MPa.

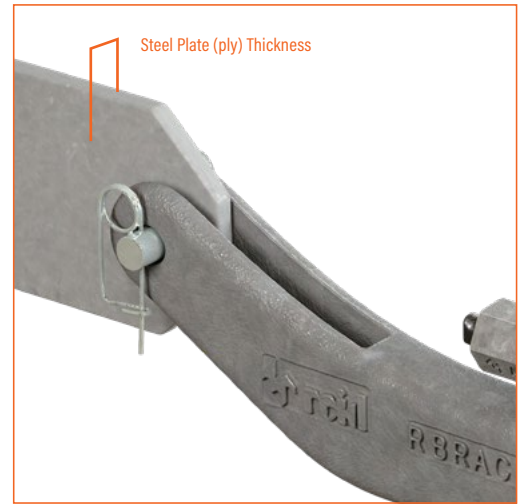

To ensure the ductile capacity of the bracing system the minimum yield strength of the steel cleat plate should be 250 MPa and the minimum plate thickness and edge distance for the hole should be as follows.

Reidbar™ size (mm)	12	16	20	25	32
Cleat thickness (mm)	10	10	16	20	30
Edge distance (mm)	32	32	40	60	60

Preloading Bracing System

Tension on structural bracing span should meet L/100 sag criteria.

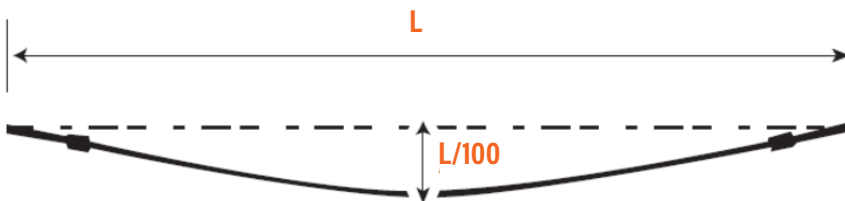

Ref:

HERA report R4-80 section 3.3.2
Woolcock, S T and Kitipornchai, S; Tension Members and Self-Weight; Steel Construction, Vol. 19, No. 1, May 1985.

ReidBrace™

Design Data

Minimum Angle of Bracing to Fixture

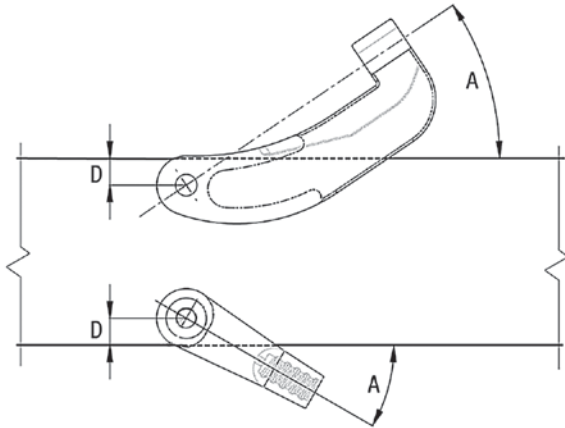

Bar Size (mm)	Edge Distance D (mm)	Brace	Min angle A°	End	Min angle A°
12	32	Rbrace12/16	30	RBRACE12END	32
16	32	Rbrace12/16	30	RBRACE16END	30
20	40	Rbrace20	32	RBRACE20END	30
25	60	Rbrace25	34	RBRACE25END	32
32	60	Rbrace32	34	RBRACE32END	30

Bar Length for Bracing Application

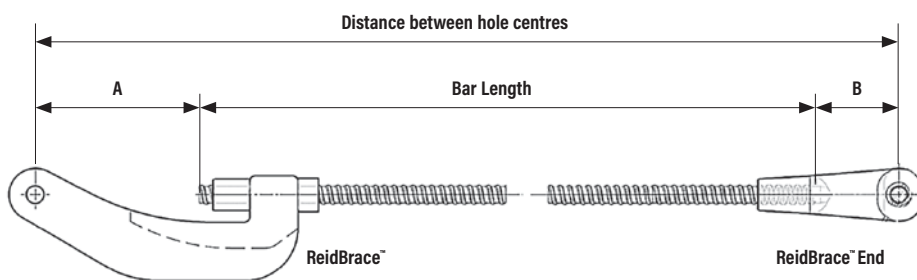

ReidBar™ Size	Brace	A +/-5mm	ReidBrace™ End	B +/-5mm	A+B mm
RB12	Rbrace12/16	135	RBRACE12END	75	210
RB16	Rbrace12/16	130	RBRACE16END	80	210
RBA20	Rbrace20	175	RBRACE20END	105	280
RB25	Rbrace25	175	RBRACE25END	125	300
RB32	Rbrace32	200	RBRACE32END	135	335

ReidBrace™

Material Data

Product Specification - Dimensions Of RBACE (mm)

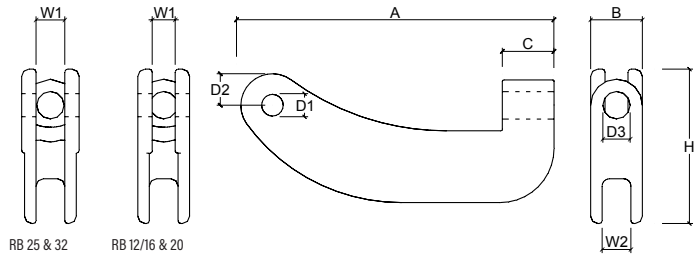

RBACE									
Size	A	B	C	D1	D2	D3	H	W1	W2
12/16	276	36	46	17	25	19	107	16	20
20	345	45	58	21	32	24	134	21	25
25	382	53	73	31	40	29	149	26	29
32	436	68	72	31	44	38	170	36	36

Product Specification - Dimensions Of RBACE-END (mm)

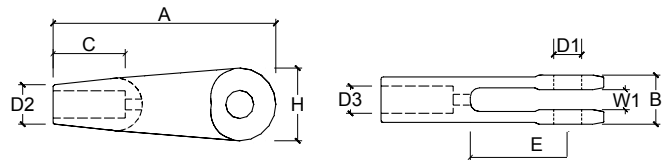

RBACE-END									
Size	A	B	C	D1	Pin	E	H	W1	D3
12	145	32	50	17	16	50	40	16	Bar Diameter
16	160	36	55	17	16	67	50	16	-
20	195	45	60	21	20	88	60	21	-
25	247	50	80	31	30	108	80	26	-
32	265	62	85	31	30	120	88	32	-

Additional notes:

- Service temperature of the ReidBrace™ system (from NZS 3404 & AS 4100), should be limited to -5°C using the above information
- This document supersedes any previous publication
- Testing follows the principles of AS/NZS 1170.0
- 3x 32mm HDG ReidBrace™ pin samples have been Charpy impact tested at 0°C with an average result of 140J.

ReidBrace™

Material Data

ReidBrace™ Pin sizes (mm)

RBRACE Set	Pin Size (Diameter x Length, mm)
RBRACE12-SET & RBRACE16-SET	16 x 50
RBRACE20-SET(A)	20 x 59
RBRACE25-SET	30 x 68
RBRACE32-SET	30 x 83



For applications requiring coupling system

When ReidBar™ bracing lengths need to be coupled, Reid™ couplers need to be used.

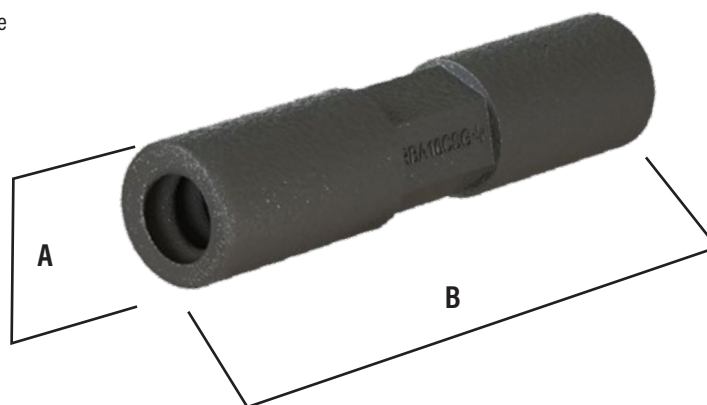

Product Code	Description	Outer Diameter (A) (mm)	Length (B) (mm)	Hex A - F (mm)
RB12C	ReidBar™ Coupler for RB12	22	90	25 - 29
RBA16C	ReidBar™ Coupler for RBA16	30	102	30 - 34
RBA20C	ReidBar™ Coupler for RBA20	33	129	36 - 42
RB25C	ReidBar™ Coupler for RB25	43	180	45 - 52
RB32C	ReidBar™ Coupler for RB32	55	210	57 - 66
RB12CG*	ReidBar™ Coupler for RB12 (Gal)	22	90	25 - 29
RBA16CG*	ReidBar™ Coupler for RBA16 (Gal)	30	102	30 - 34
RBA20CG*	ReidBar™ Coupler for RBA20 (Gal)	33	129	36 - 42
RB25CG*	ReidBar™ Coupler for RB25 (Gal)	43	180	45 - 52
RB32CG*	ReidBar™ Coupler for RB32 (Gal)	55	210	57 - 66

* lead times applies for Hot Dip Galvanised components

ReidBrace™

Installation Guidelines



Step 1: Checks

1. Check if all RBRACE components are in the box.
2. Check if the RBRACE fitting flanges will fit onto the steel cleat.

Boxed Set contents:

1. Reid™ Tension Spring
2. Reid™ Tab Washer
3. RBRACE
4. RBRACE-END
5. Pin and Clip
6. ReidBar™ nuts x 2

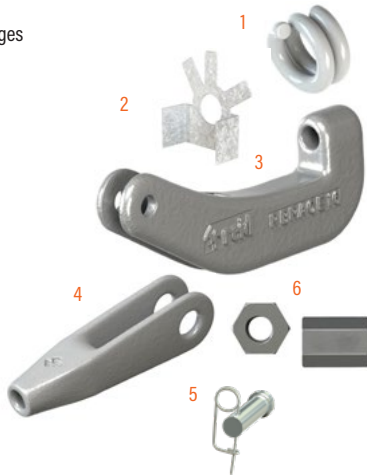

Step 3: Assemble



1. Insert ReidBar™ into the RBRACE-END fitting and tighten.
2. Insert ReidBar™ Half Nut (or one full nut in 20mm sets) into the other side of the bar, followed by inserting the tension spring.
3. Slide the RBRACE Fitting onto the ReidBar™, followed by inserting the tab washer onto the ReidBar™ with the tabs facing the nut.

Step 2: Measure

1. Measure the centre to centre distance between the holes on the steel cleat.
2. Subtract the above length by A+B as per the following table. This is the length of ReidBar™ to be cut.

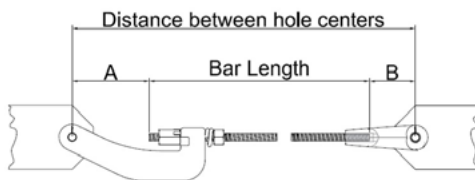

ReidBar™ Size	RBRACE	A ± 5mm	RBRACE__-END	B ± 5mm	A + B (mm)
RB12	RBRACE12/16	135	RBRACE12END	75	210
RBA16	RBRACE12/16	130	RBRACE16END	80	210
RBA20	RBRACE20(A)	170	RBRACE20END	105	275
RB25	RBRACE25	175	RBRACE25END	125	300
RB32	RBRACE32	200	RBRACE32END	135	335

Components assembly sequence are as follows.



4. Wind ReidBar™ Nut onto the ReidBar™ until it is flush with the end of the ReidBar™. This will give adjustability to the RBRACE fitting upon installation.

ReidBrace™

Installation Guidelines

Step 4: Install

1. Lift the ReidBrace™ assembly into location.
2. Fix the RBRACE-END fitting onto the steel cleat using the pin supplied in the box set. Clip through hole in pin.

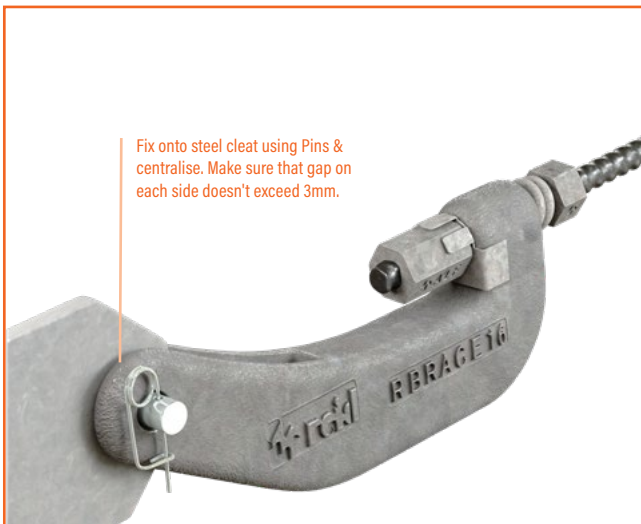

3. Place necessary means to prop the ReidBrace™ assembly so that the sag of the brace is not excessive. A sag of 1 in 100 is recommended as a maximum deflection (refer to HERA: Seismic Design of Steel Structures).
4. Fix the RBRACE fitting onto the steel cleat using the pin supplied in the box set. Fix clip through hole in pin.
5. Adjust the positions of the nuts so that the 1 in 100 maximum deflection criteria is met.
6. Tighten the Nut to fully compress the tension spring. Fold the tab washers onto the ReidBar™ Nut.

Step 5: Check



1. ReidBar™ is tightly fastened into the RBRACE-END fitting.
2. The deflection of the brace shall not exceed 1 in 100 of the brace length.

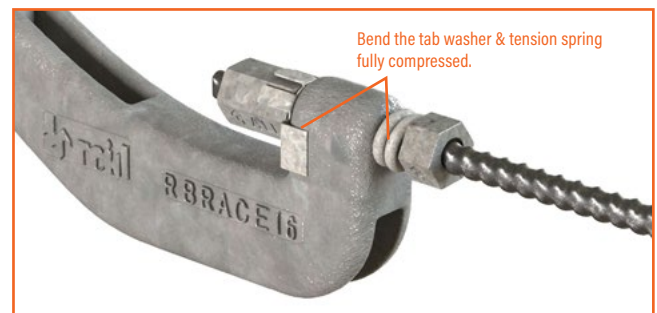

3. Tension spring is fully compressed.
4. Tab washer is folded onto the ReidBar™ Nut.
5. Supplied Pins and Clips are securely fixed to steel.

Design Tools

Ramset™ provides assistance for Engineers to choose a suitable anchoring solution which meets a project specific set of design inputs such as:

- Design tools for considering complex anchor layouts & calculating performance in grouped anchor configurations.
- Tailored outcomes to suit project specific anchoring and performance criteria.
- The latest design technology and performance calculation tools are available in hard copy or electronic format.

Specifiers Resource

This concise and systematically presented book contains the information most useful to Specifiers, Engineers and Architects when selecting the concrete anchoring solution that best suits their project. Selection of a concrete anchoring product is made on the basis of the basic type of fixing (bolt, stud or internally threaded), macro environment, (e.g. coastal or inland), micro environment (particular chemicals) and of course the capacity that best meets the design load case.

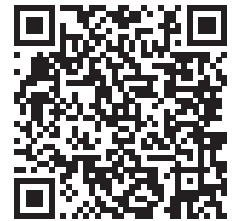

Scan for more information



Ramset™ iExpert™



- iExpert™ is our online anchoring design tool, which allows Engineers and design professional to work out the best product solutions for an application in line with AUS/NZ Standards.
- Featuring a simple 6 step design process, iExpert™ then provides a design report document once all the parameters have been assigned.
- Applications
- Cracked and uncracked concrete
- Seismic
- Fire



Scan for more information

Important Disclaimer: Any engineering information or advice ("Information") provided by Ramset™ in this document is issued in accordance with a prescribed standard, published performance data or design software. It is the responsibility of the user to obtain its own independent engineering (or other) advice to assess the suitability of the Information for its own requirements. To the extent permitted by law, Ramset™ will not be liable to the recipient or any third party for any direct or indirect loss or liability arising out of, or in connection with, the Information.

Ramset™ Australia

Sales, Orders and Enquiries

Tel: 1300 780 063

Fax: 1300 780 064

Web: www.ramset.com.au

Australian Trade Centre

New South Wales

71 Carnarvon Street,
Silverwater, 2128

